

TECHNOLOGICAL INNOVATION

Garage doors
and patented locking systems

 **OVERLAP**
move to space



COMPANY



Delta Overlap mission and corporate values



Delta Overlap manufacturing operation was established on December 2013 as part of the Delta SpA group of companies. Delta Spa was created in 1972 as a manufacturer of rubber and polyurethane components and is now a world leader thanks to its specific knowledge and the technologies developed in this industry.

Specifically Delta Overlap mission is the development of the Overlap technology for the garage door residential market and extend the use of this patented technology to other areas like the industrial and the technical domain.

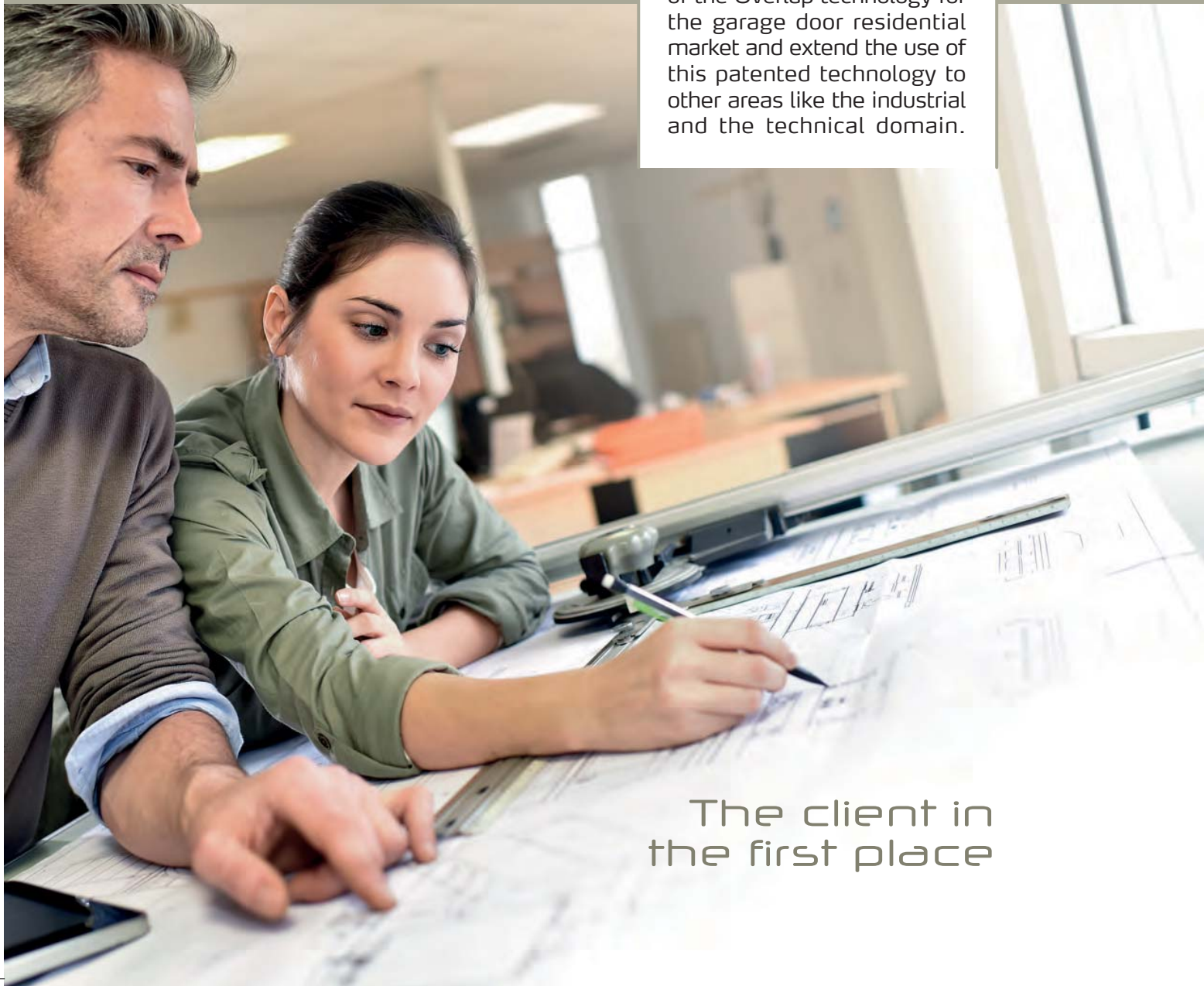

The client in
the first place



Delta Overlap is already a leading manufacturer and industry reference within the high end residential garage door market with a dedicated production facility and highly skilled staff.



Our team is an added value

PATENT





Overlap in an innovative concept that does not require the ceiling tracks and reduces the space occupied inside the garage. The operator is housed in the upper beam of the door frame.



This solution operates the two sections of the door without the need of the tracks inside the garage where the first section acts as the track and rail for the second section that follows beneath.

The garage doors with Overlap patented technology



Traditional sectional garage door

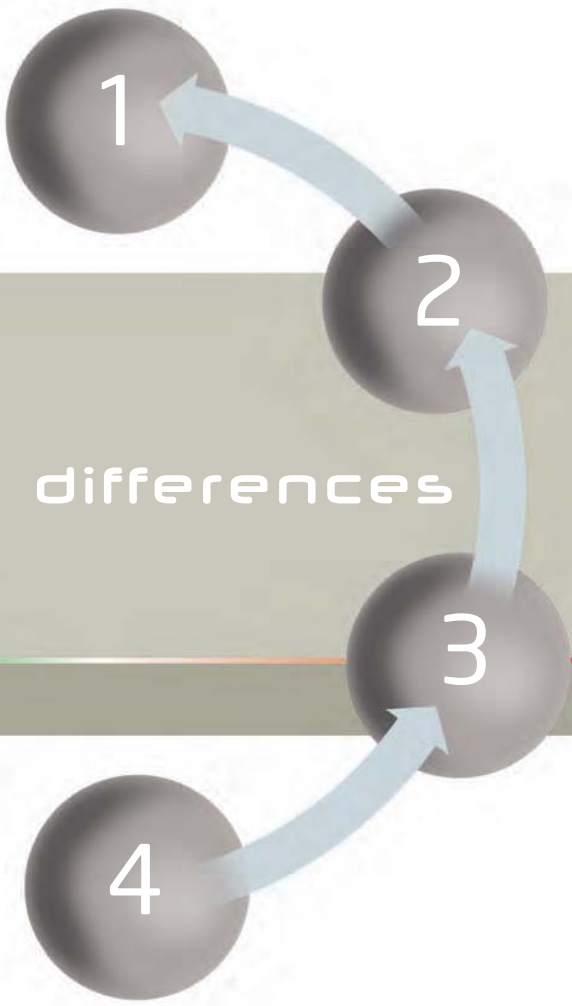

1 Ceiling rails

When the traditional sectional garage door opens it moves parallel to the ceiling along the tracks which are fixed on the ceiling which then remain in place even when the door is closed.

2 Operator

The motor is also fixed to the ceiling and takes considerable space inside the room.

3 Spring operated system

The traditional garage door opens and shuts with the help of metal springs which are sized for specific open/close cycles, are under mechanical stress and undergo wear and tear with the time.

4 Appearance

The presence of many individual sectional panels require various hinges and hardware on the internal side of the garage and do not enhance the appearance on the external side too.



Overlap door

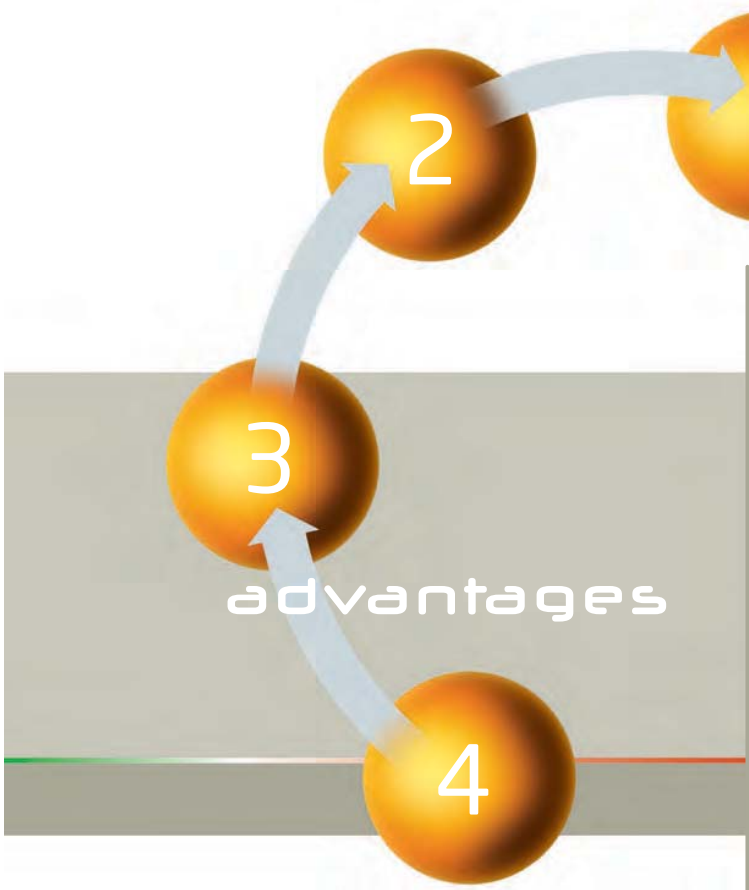

1 Trackless

This is the main feature that makes Overlap a unique selling proposition. Thanks to its self-standing frame and the two stackable sections, Overlap does not require the unsightly ceiling rails.

2 Operator positioned inside the frame

The motor is housed inside the upper beam of the door frame, does not need sliding structures and does not reduce the net passage (height) of the garage door.

3 Counterweight system

The mechanical movement of the panels is provided by double counterweights on each side of the frame and as a consequence parts exposed to wear and tear are reduced to a minimum.

4 Appearance

This innovation makes a clean and orderly garage space both inside and outside and offer bespoke solutions in sizes and finishes.



DESIGN AND APPEARANCE

**Engineered
for functionality,
appearance
and precision**

The attention to details, the manufacturing technology and the wide range of finishes and claddings result in an external appearance that fit easily in every type of house with an elegant and peculiar look. The charm of an Overlap door is unique and peerless.

More space for your space

The attention to details is maintained both on the inside as well as outside. The trackless construction, the hidden operator, the white or anthracite frame of the internal finishes result in a pleasant and elegant solution. The internal side of the panels are spray painted white and on request the panels can be customised with other colours.

The space that creates a fine view

The innovative Overlap system does not need tracks on the ceiling and halves the backroom needed when the door is open. Overlap is space efficient both inside the garage and the reduction of the net passage both in the height and the width is reduced at a minimum. When the door is open the reduction of the clearance is only 200 mm. Overlap is the ideal choice in presence of an inclined or a vaulted ceiling, ceiling with beams showing and side walls placed at an angle or curved.



More space, more comfort

ideal for low-depth garages
or openings flush with the street.

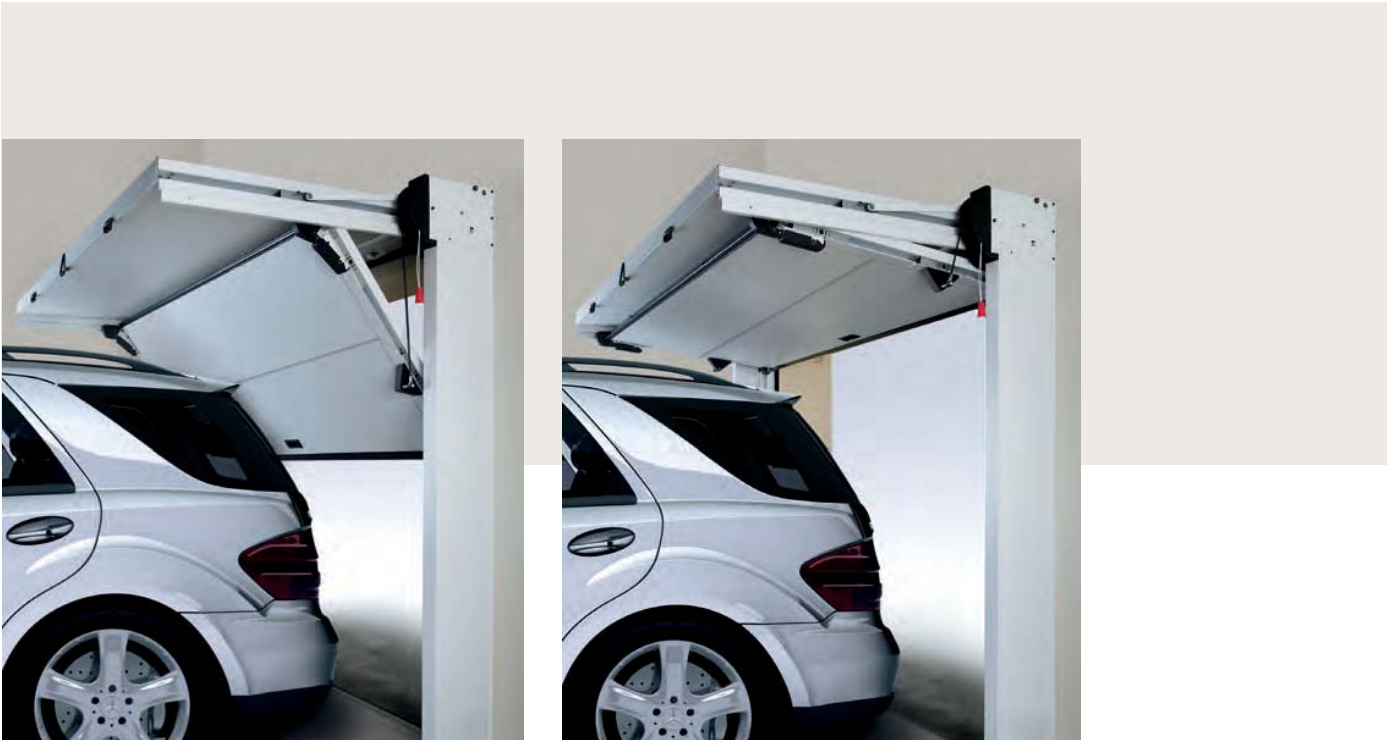
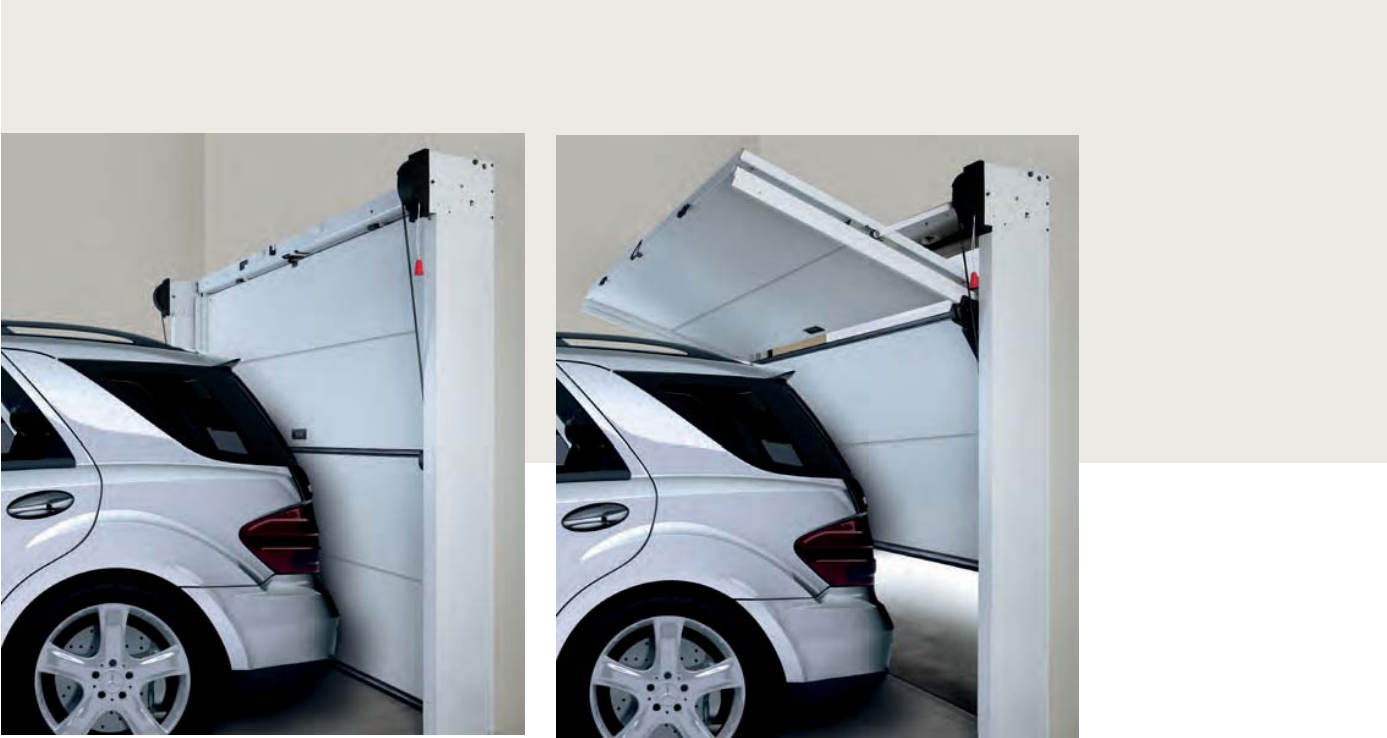

Energy Efficient

The electronically controlled Overlap motorization drives a triple magnetic clutch and one mechanical clutch linked to the counterweights. This design is energy efficient.

Overlap cuts out well wind and water, offer sound insulation when closed and quiet and smooth operation when opening and closing. Overlap has a thermal transmittance up to $U = 1.50 \text{ W/m}^2 \text{ K}$ with standard blind door when fitted behind the reveal.

Reduced energy consumption and thermal insulation

THERMAL TRANSMITTANCE
up to $U = 1,50 \text{ W/m}^2 \text{ K}^*$

*value obtained for a door without windows and grills with behind wall installation

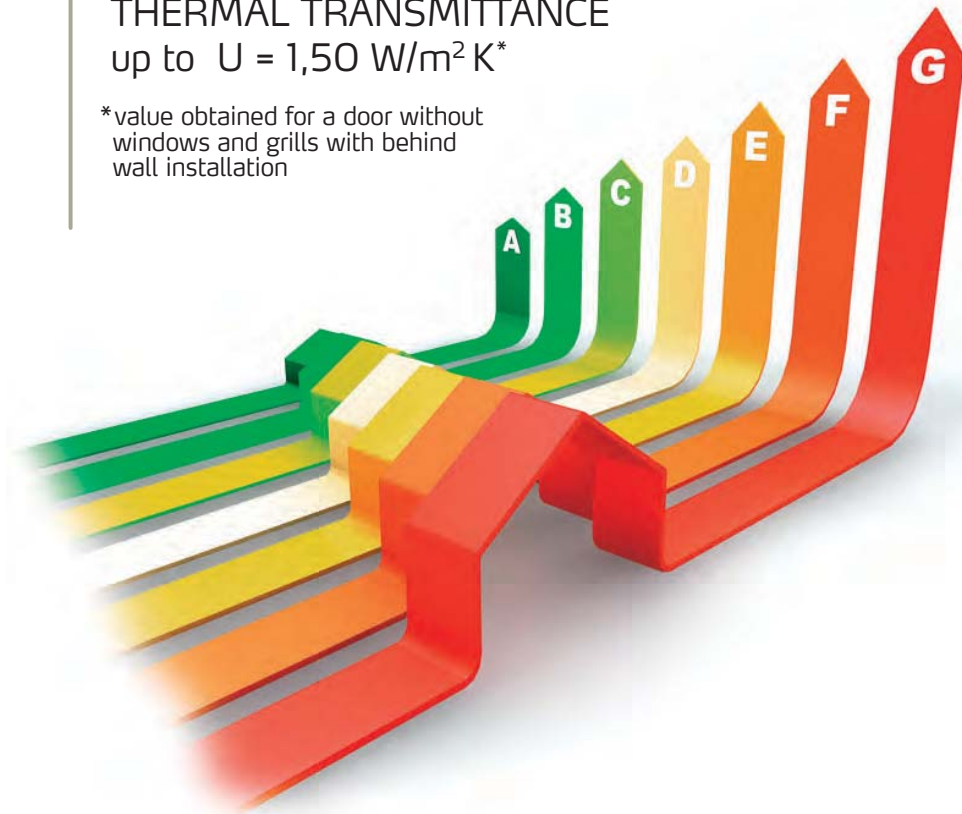



Safety and technology

Theft-proof door and safety during operation

App for iOS
- Android



Certified
ACCORDING TO
EN 1627 CLASS 2
BREAK-IN
RESISTANCE



Overlap boasts high safety standards. The locking system offers theft-proof features and the Overlap motor can be linked to any alarm or electronic, automatic management system in the house. The electric sensors in the motor prevent injuries when closing and the photocells inside and out offer additional safety.

The setting of the motor is carried out via a Bluetooth app by authorized service engineers.

Overlap has passed the testing according to EN 1627 and has achieved class 2 resistance against attempts of forcing the lock. The continuous Overlap product development can now offer a garage door which is very difficult to break open with non-motorized tools. The certification is applicable to all models and sizes with 40 mm panels.

Italian Style

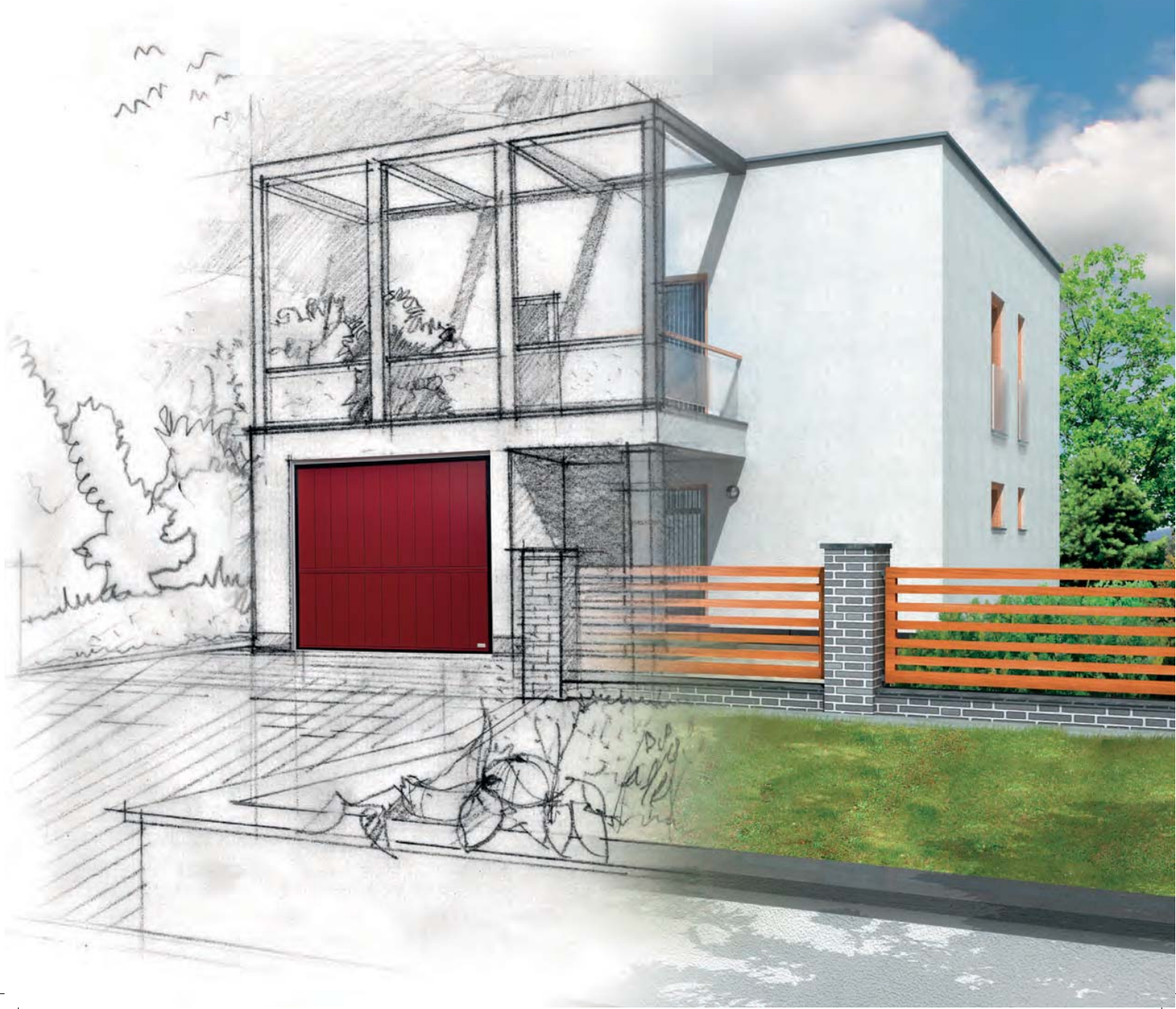



Mission possible

Overlap makes it possible numerous customized solutions to provide you with the garage of your dreams. The Overlap system is suitable also for non-garage environments when a technical access is needed and at the same time the appearance is important or there are space constraints.

Bespoke solutions

Overlap is made to measure and customized each time, with different materials, claddings and colours.





Overlap
listens to
your ideas
and gives
shape to
your project





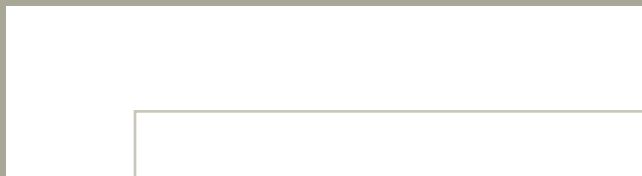
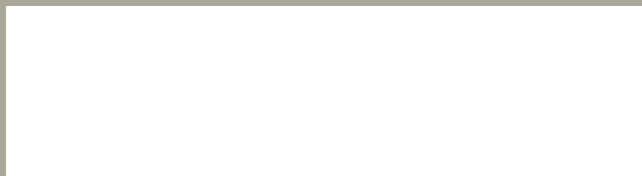

PLANA MODELS

Overlap Plana offers beautiful garage doors solutions with unique features to get everything tidied up. Overlap Plana is available with finishes WOOD, COLOR, MATERIAL in the different combinations of colours and claddings and the exclusive FULL GLASS.



Overlap Full Glass is made with safety glass and allow the day light to brighten your garage. Overlap Full Glass is a garage door with clear glass, satin glass and tinted glass suitable when you want natural light for your garage, working space or to create a showroom.

FULL GLASS



Mod. PLANA - Full Glass - Transparent glass

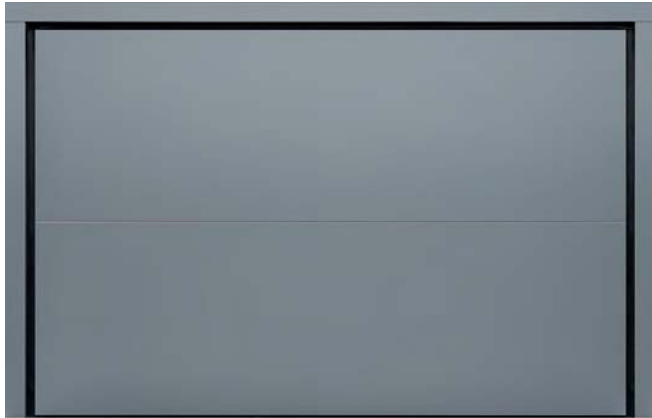

The finish Color for a modern and personal look.

COLOR



Mod. PLANA - Color - 713 Metal



WOOD

This finish enhances the beauty of wood.



Mod. PLANA - Wood - 770 Yale Oak



This finish is innovative and modern for a contemporary appearance, with Corten finish and other colours.

MATERIAL

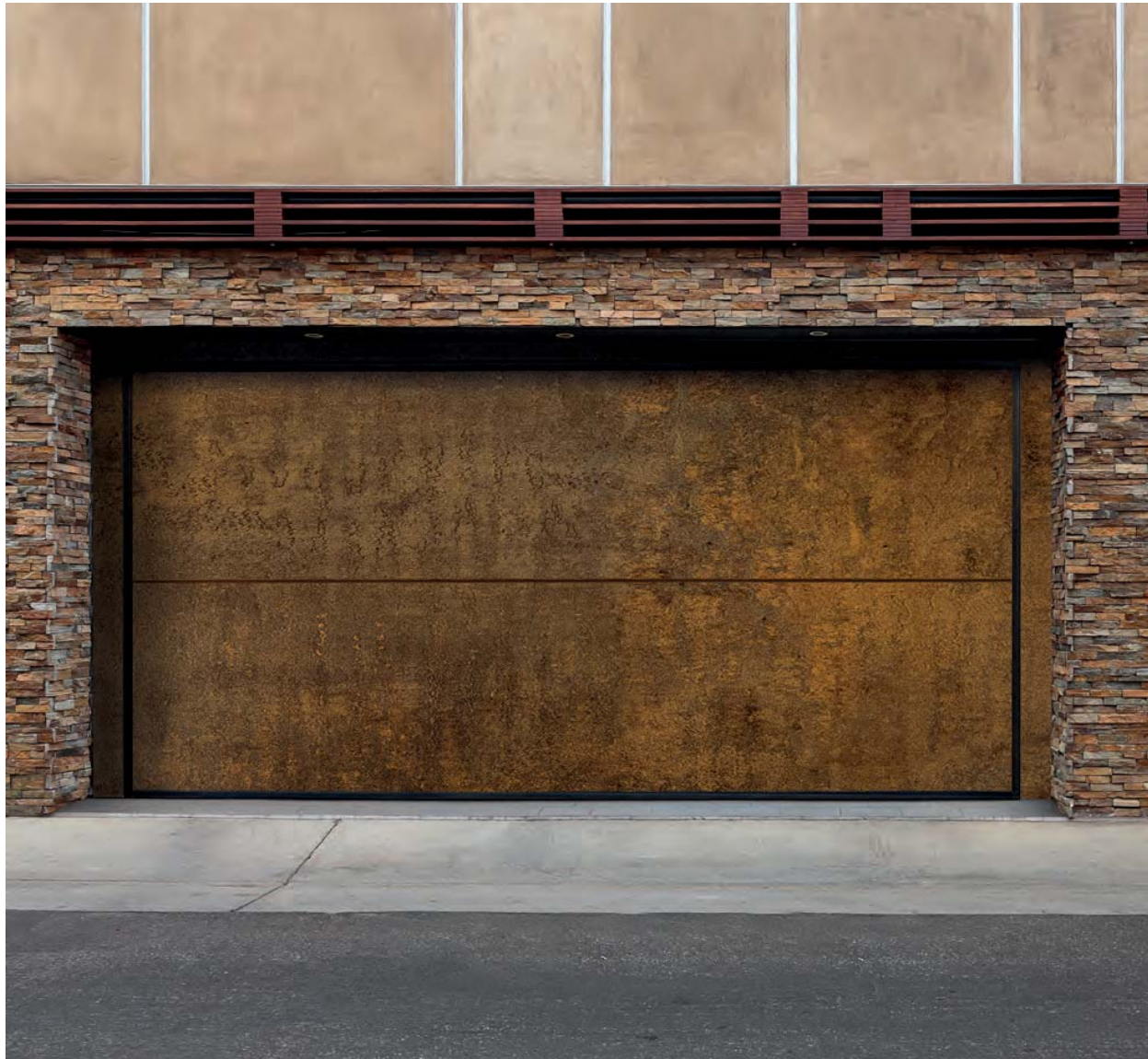

Mod. PLANA - Material - 0794 Patina Bronze

Models for comfortable solutions



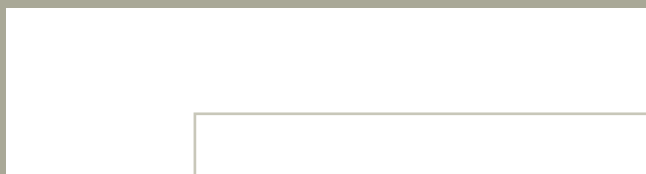
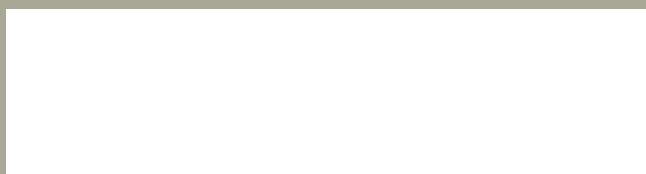

CLASSIC MODELS

Overlap Classic offer options suitable for every house, modern or traditional, with a wide choice of finishes and colours that result in a unique appearance.



AIR

Smooth panels create a minimalistic look.

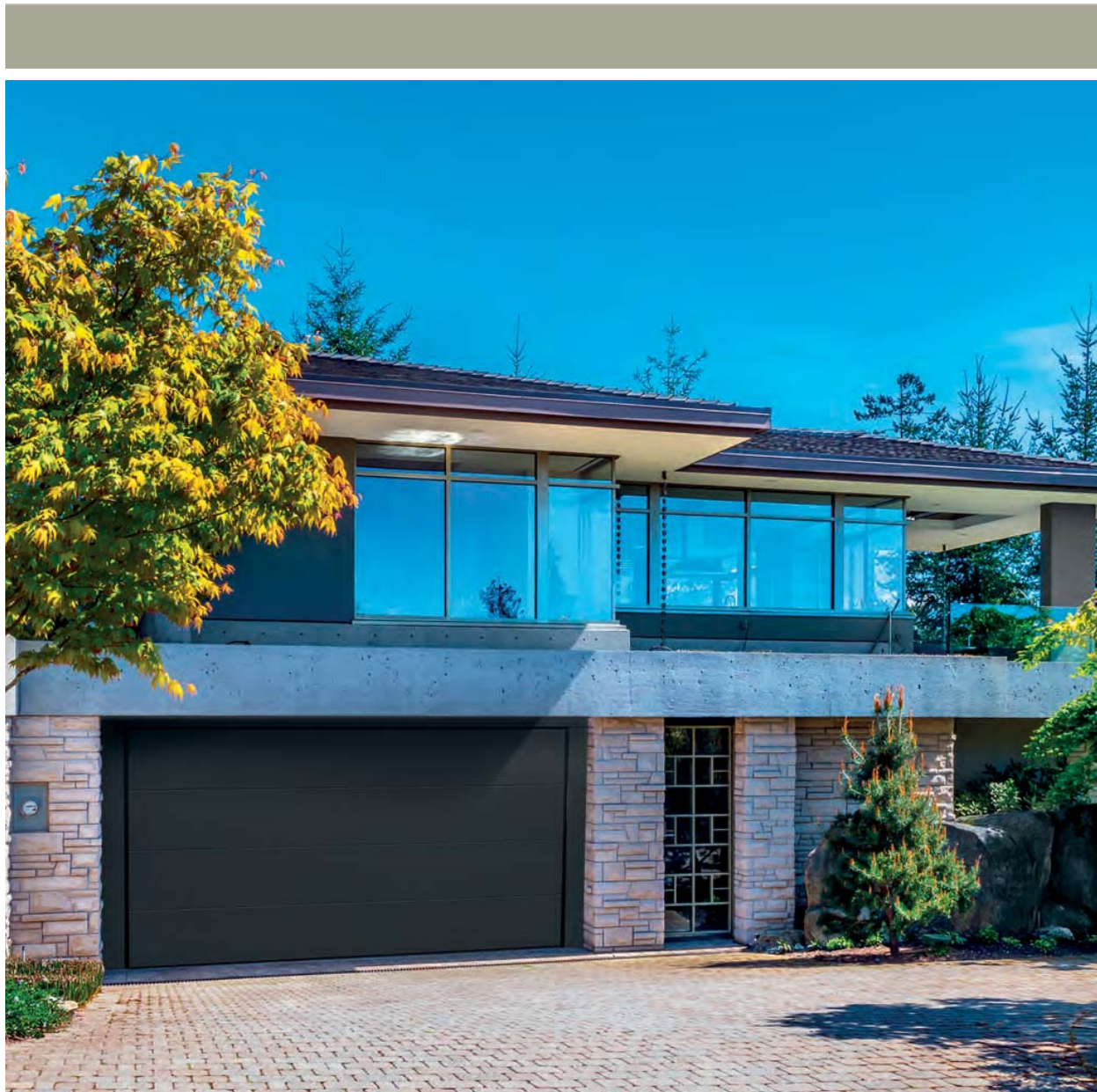

Mod. AIR - Slightgrain - RAL 7016 Anthracite grey



WIDE

Grooved panels offer a noticeable pattern.



Mod. WIDE - Woodgrain - RAL 9016 Traffic white



Additional grooves on the same panel enhance the pattern.

SOUND

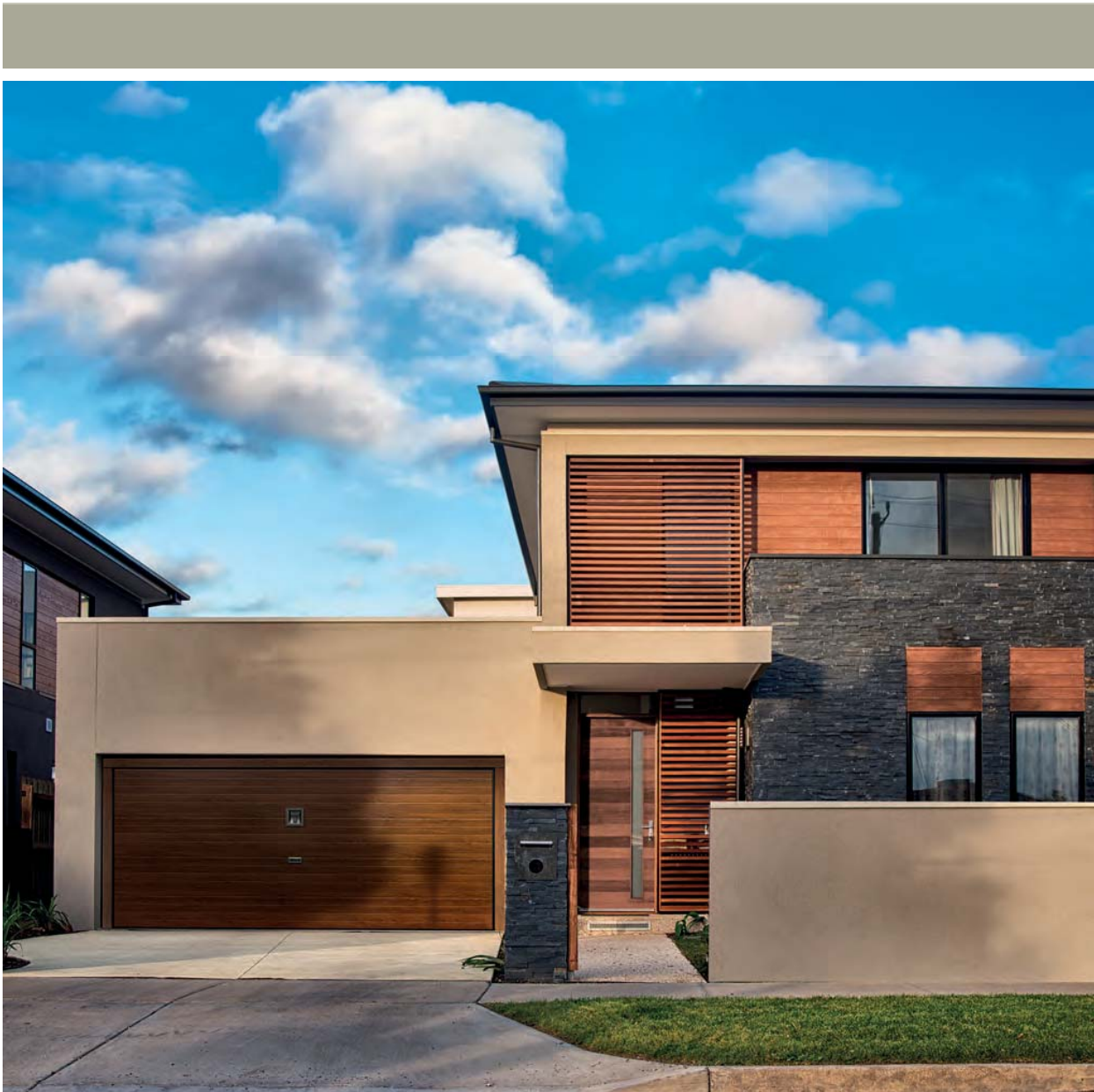

Mod. SOUND - Woodstyle - Medium with double handle



This peculiar pattern gives a distinctive look to the door.

WAVE



Mod. WAVE - Smooth - RAL 9016 with double handle



This cassette pattern is suitable for more classic and traditional settings.

BOX



Mod. BOX - Woodtsyle - Light

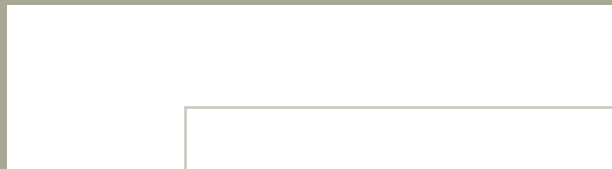
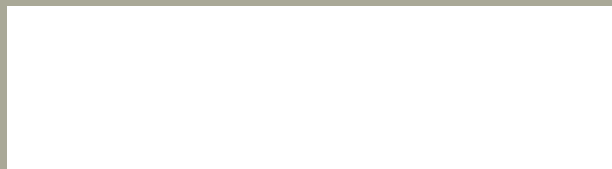

Overbas up and
Over Doors



Overbas

The Overlap
up and over
garage door.



All the advantages
OVERLAP

- 1 Concealed operator
- 2 Trackless solution
- 3 Counterweights movement
- 4 Approved for break-in resistance Class 2*

Feasible in all the Overlap
aesthetic of Plana e Classic
Range

*The security feature is not available with wicket door.



Internal
view

Plus

The wicket door with concealed hinges and low threshold is available.



Threshold
lowered



Concealed
hinges

Installation types

Overlap - Overbas



Between wall installation

This installation type is suited in case the wall opening does not allow fixing behind the opening. It is especially common in the case of a door replacement. Thanks to the self-supporting frame, Overlap doors with outer frame dimensions until can be directly fixed to sidewalls and over-wall with no other supporting component (e.g. Tubular, etc.) which is otherwise necessary for bigger dimension doors.



Behind wall installation

This installation is performed when the wall opening presents enough side-room and head-room. In this case, the door frame is anchored behind the wall and it is possible to maximize door clearance. This solution should be preferred as it allows a better thermal insulation of the garage.

Sizes

OVERLAP and OVERBAS are always made, both in width and height in steps of 50 mm or 10mm (optional). Overbas not protruding feasible up to 3970mm x 2680mm.

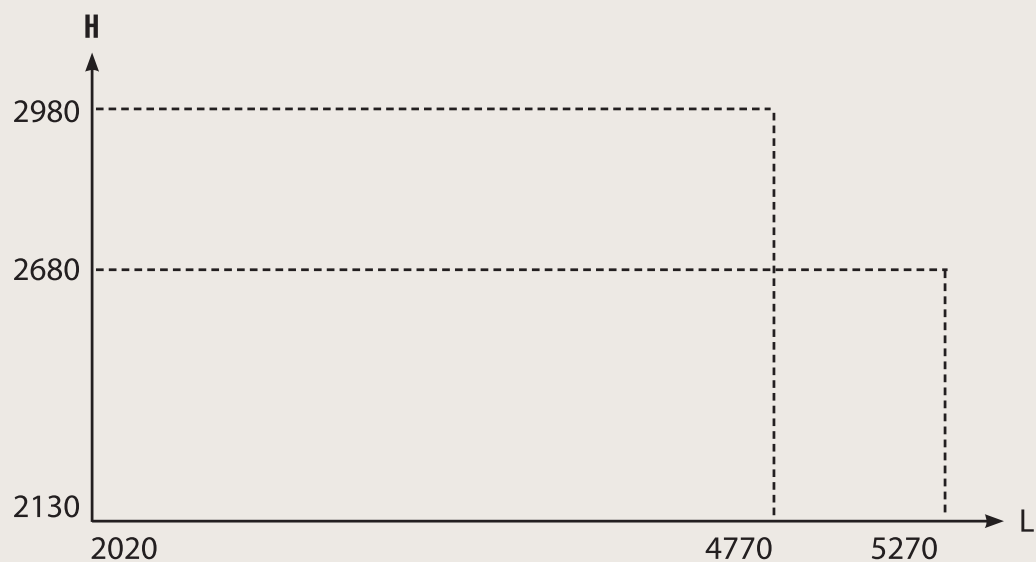

Size table classic models: outer frame size (mm)

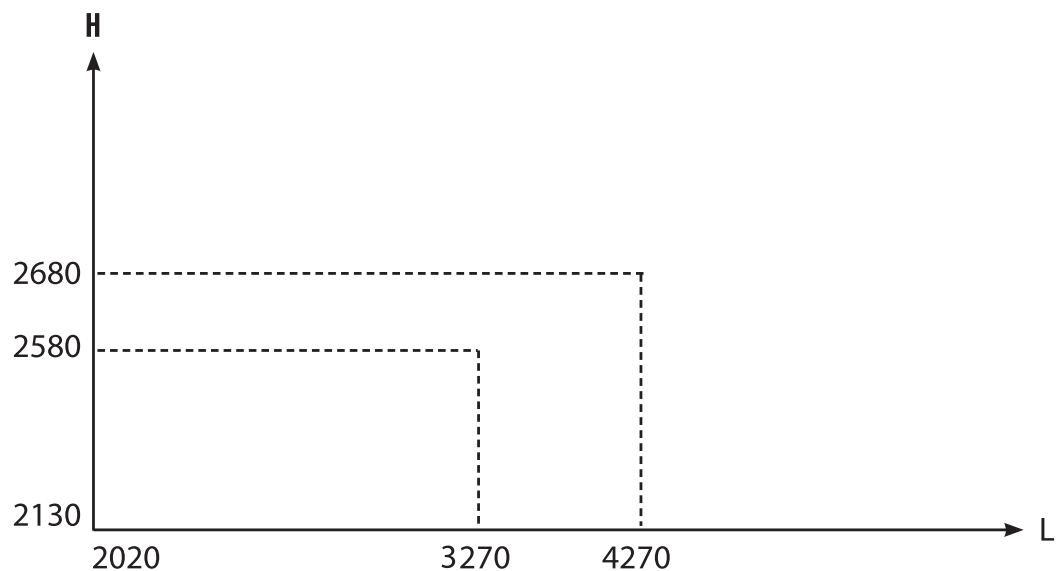

Size table plana models: outer frame size (mm)

Full Glass feasible up to L 3270 x H 2580
Color, Wood, Material up to L 4270 x H 2680



COLORS AND SURFACES

Classic Models Surfaces

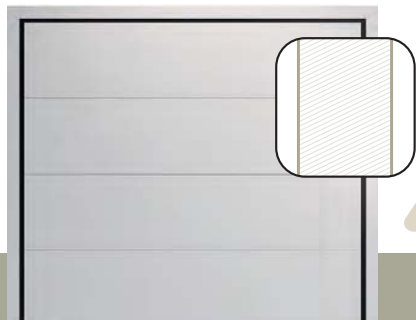

AIR

WOODGRAIN, SLIGHTGRAIN,
WOODSTYLE AND WOODSTYLE PLUS

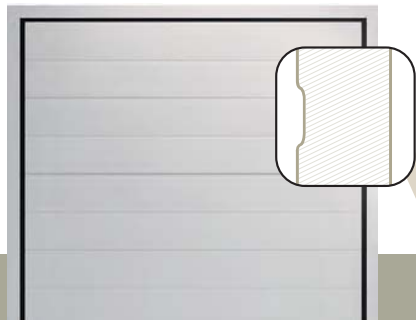

WIDE

WOODGRAIN, SLIGHTGRAIN,
WOODSTYLE AND WOODSTYLE PLUS

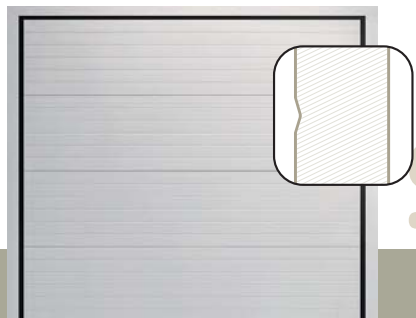

SOUND

WOODGRAIN, SLIGHTGRAIN,
WOODSTYLE AND WOODSTYLE PLUS

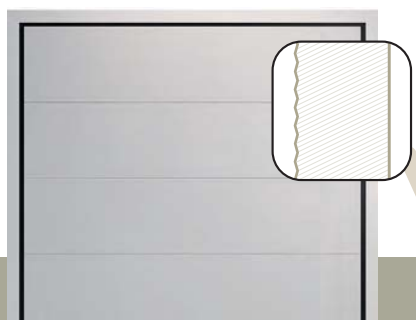

WAVE

SMOOTH



BOX

WOODGRAIN, WOODSTYLE

Surfaces



WOODGRAIN

An embossed surface that reflects the texture of wood grain, a classic and external finish.

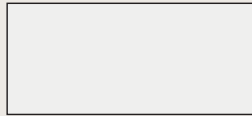

SMOOTH

A smooth and bright surface that intensify color and door style.

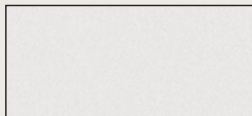

SLIGHTGRAIN

A smooth surface with a little texture that gives to the color a modern style.



WOODSTYLE

A PVC laminated smooth surface which reflects the color and grain of timber.



WOODSTYLE PLUS

A preprinted smooth surface which reflects the color and grain of timber in the external and internal of panel.

Smooth - Slightgrain - Woodgrain

Overlap is made in all ral colors or sample colors (optional)



9016 Traffic White



7035 Light Grey



9002 Grey White

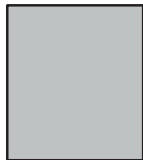

7040 Window Grey



9006 White Aluminium

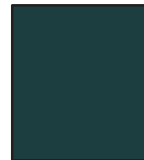

5003 Sapphire Blue



6005 Moss Grey



3003 Ruby Red



6009 Fir Green



7016 Anthracite Grey



8016 Mahogany Brown

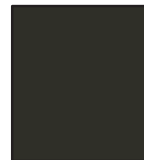

8019 Grey Brown

Woodstyle

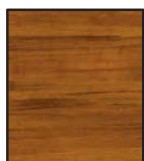

Light

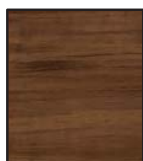

Medium



Medium-dark

Woodstyle Plus



Light



Medium

Plana Models Surfaces

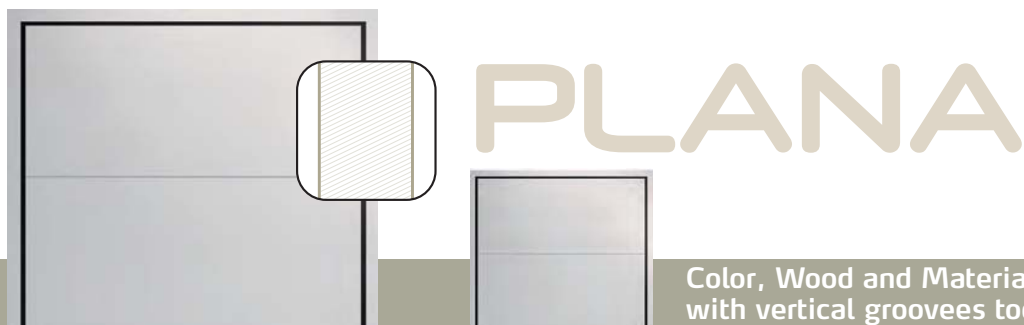

Color

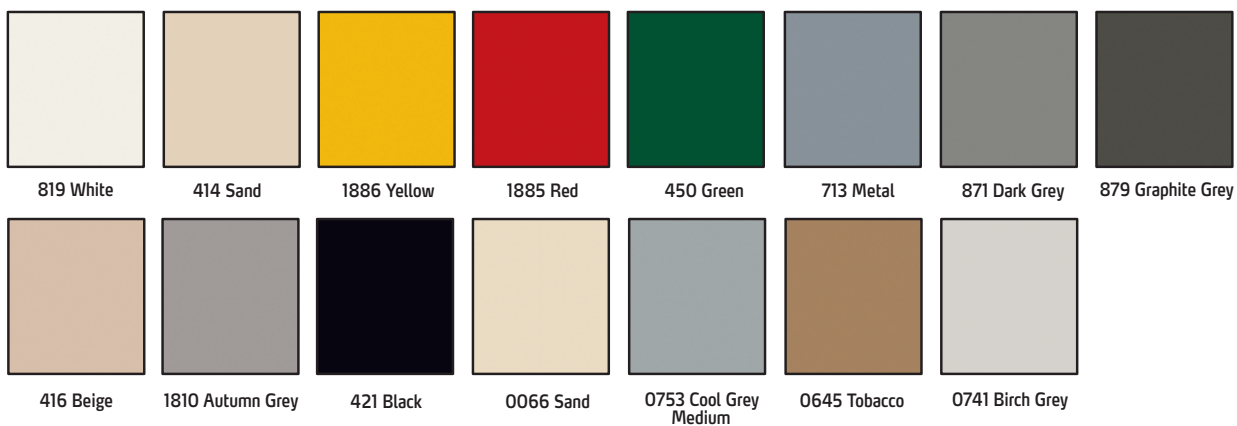

Wood

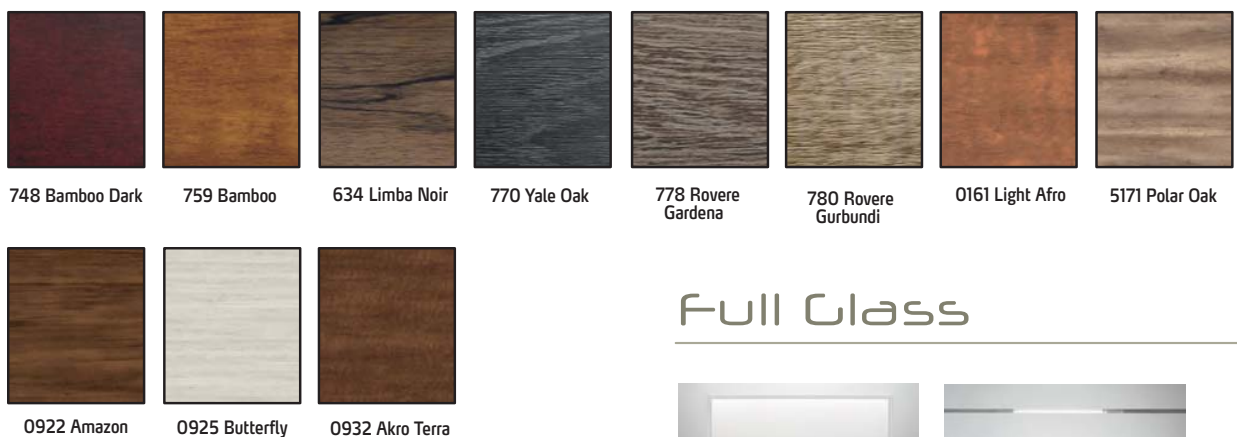

Material



Full Glass



ACCESSORIES



Two channels and four channels remote controls



External handle in PlatinBronze or PlatinSilver



Two channels wired-radio stainless steel keypadtwo



Flashing light



GSM module for door opening and closing by remote

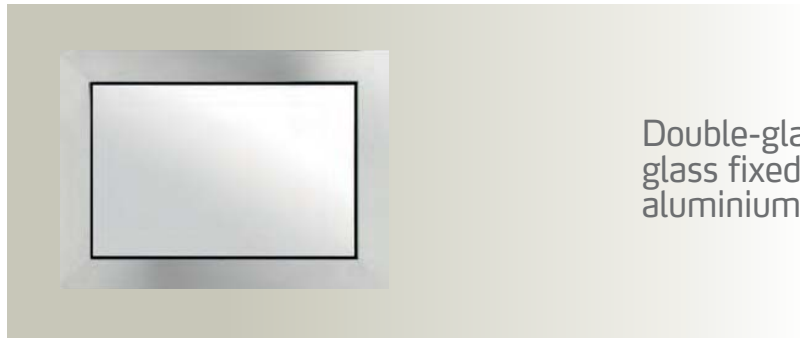

Double-glazed stratified glass fixed windows with aluminium frame

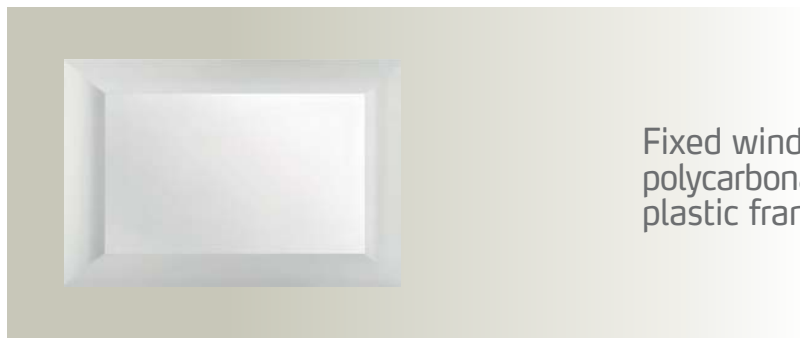

Fixed windows with polycarbonate pane with plastic frame



Plastic rectangular ventilation grill



Rectangular aluminium ventilation grill

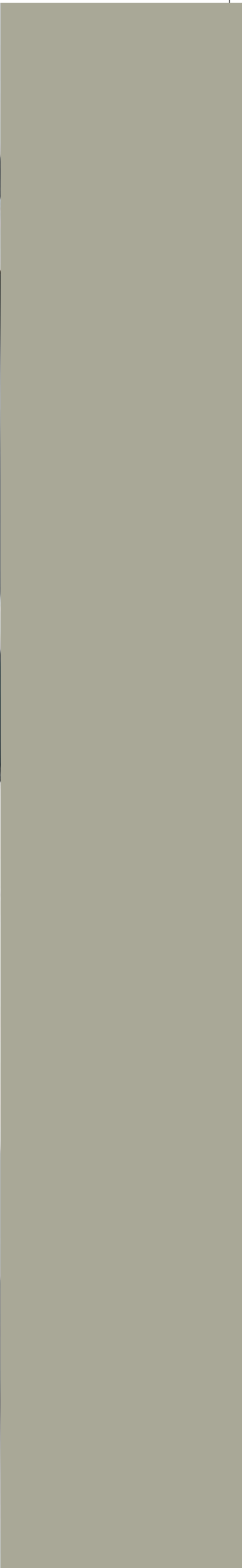

TECHNICAL
SECTION

Overlap Solutions

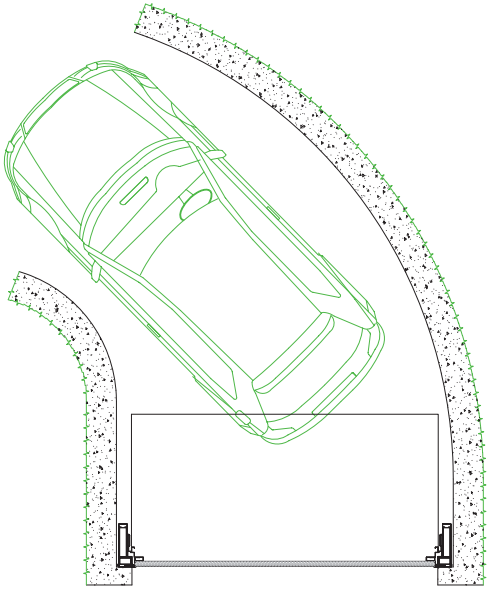

Garage with curved side walls

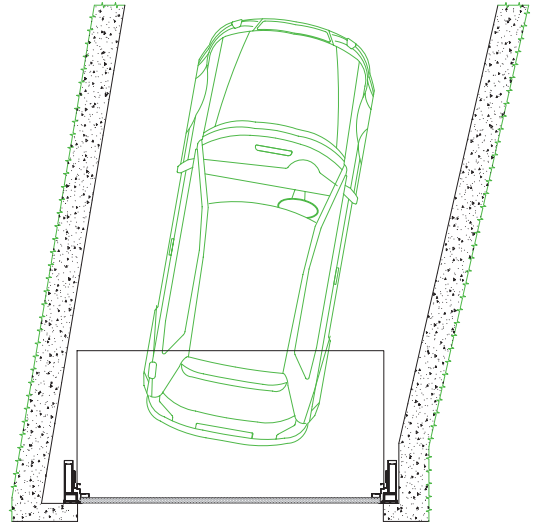

Garage with oblique side walls

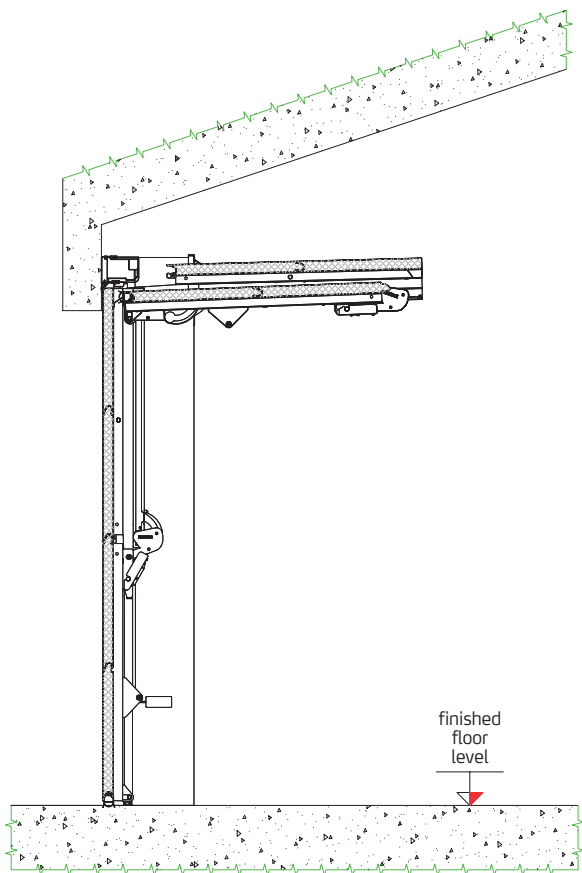

Garage with slanted ceiling

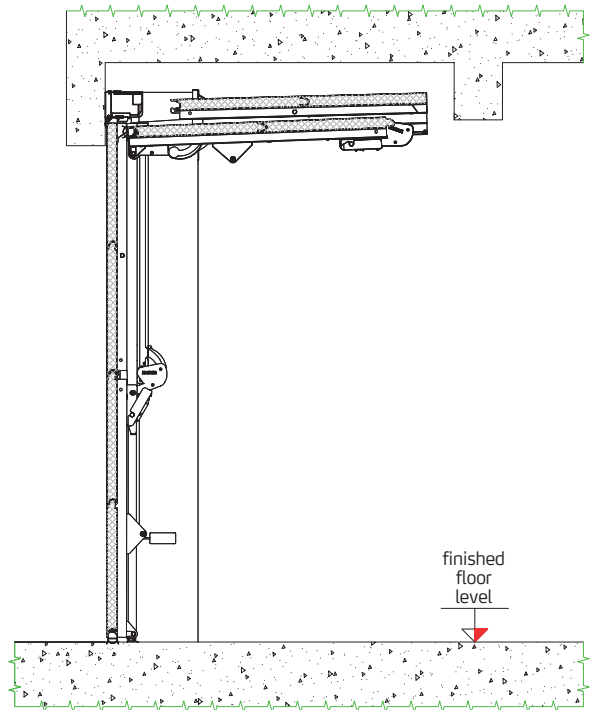

Garage with ceiling lowered by beams

BEHIND WALL INSTALLATION

Horizontal section - general

Horizontal section - detail

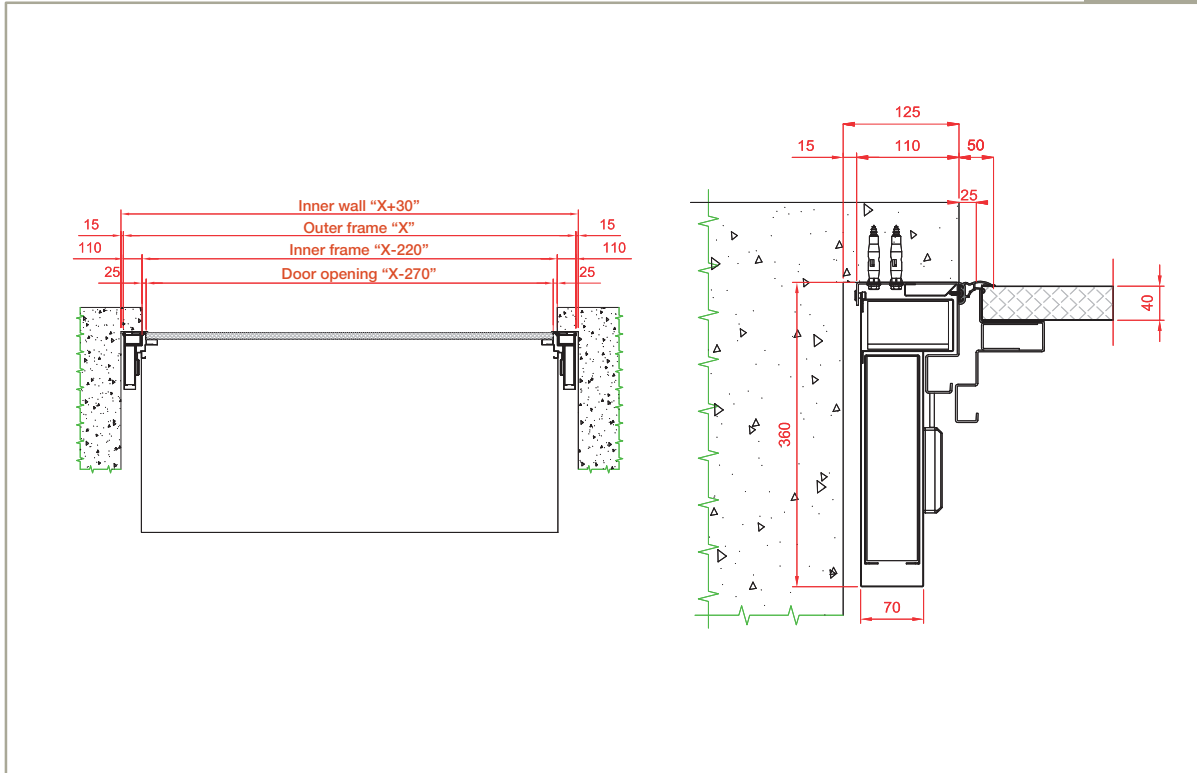

Vertical section - general

Vertical section - detail

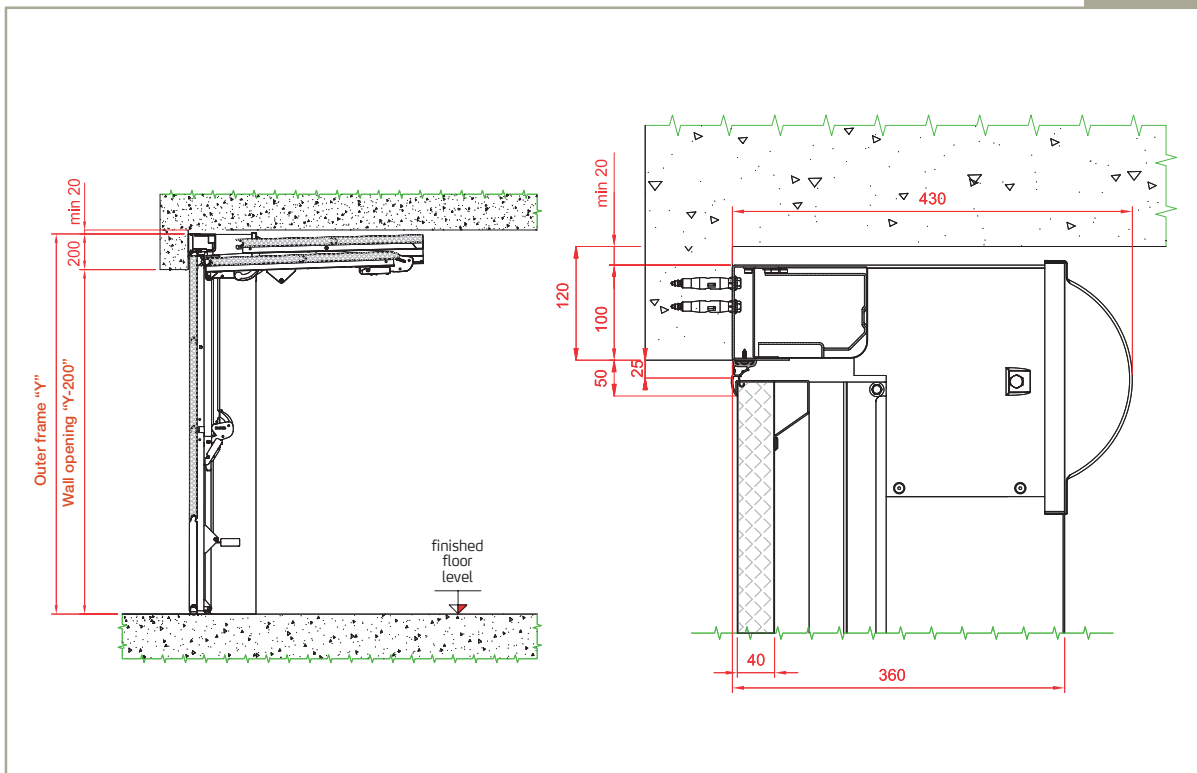

**BETWEEN WALL INSTALLATION, DOORS SECTORS A-B-C-D
(WITHOUT TUBULARS)**

Horizontal section - general

Horizontal section - detail

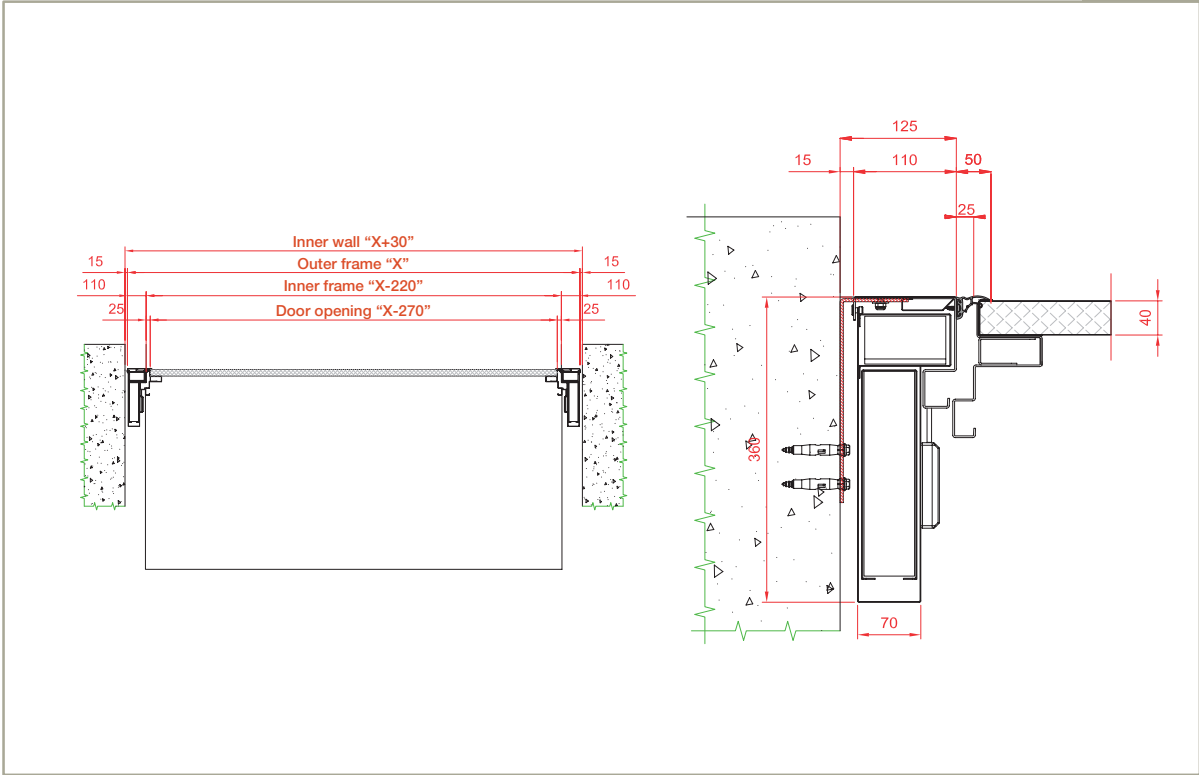

Vertical section - general

Vertical section - detail

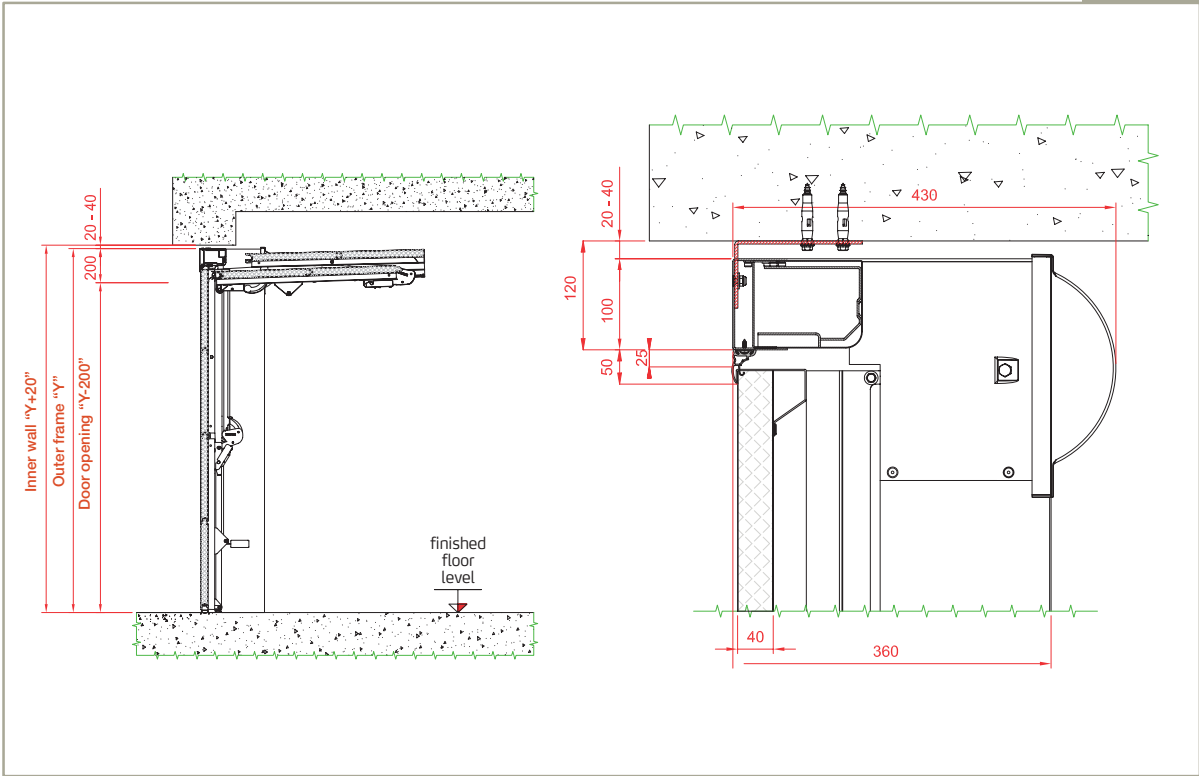

BETWEEN WALL INSTALLATION, DOORS SECTORS E F G H I (WITH TUBULARS)

Horizontal section - general

Horizontal section - detail

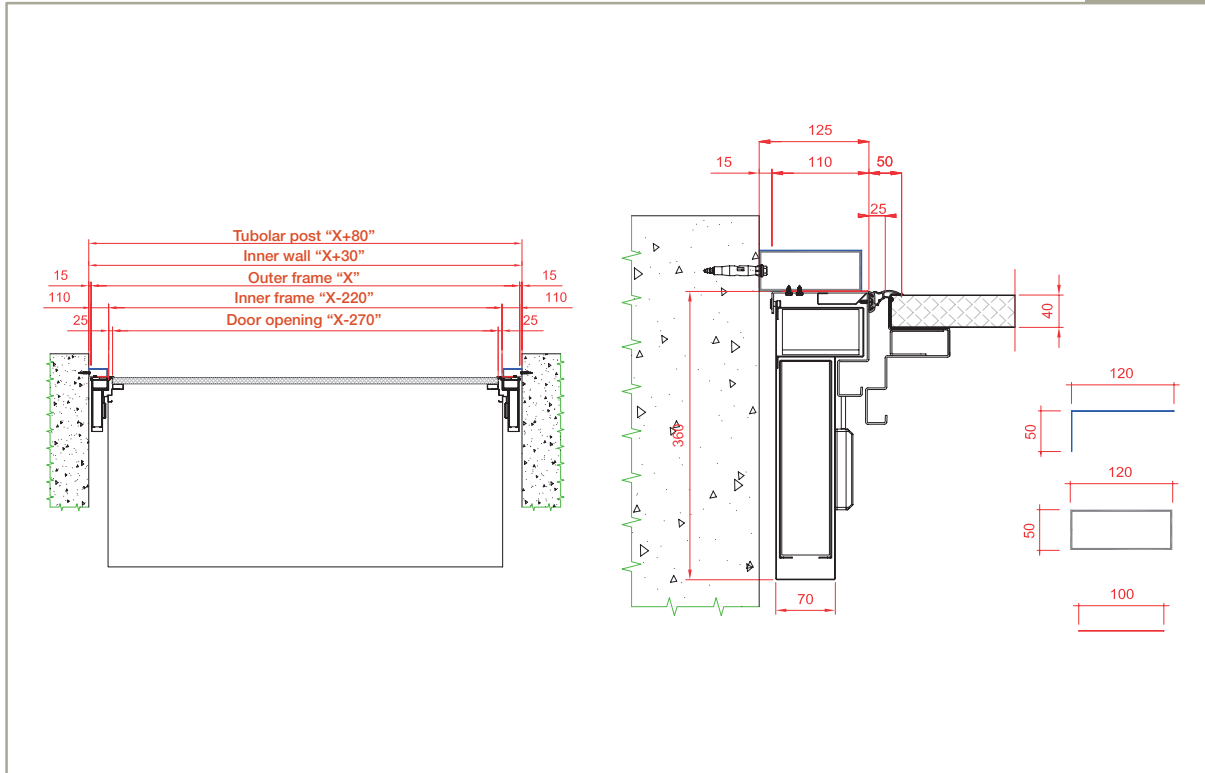

Vertical section - general

Vertical section - detail

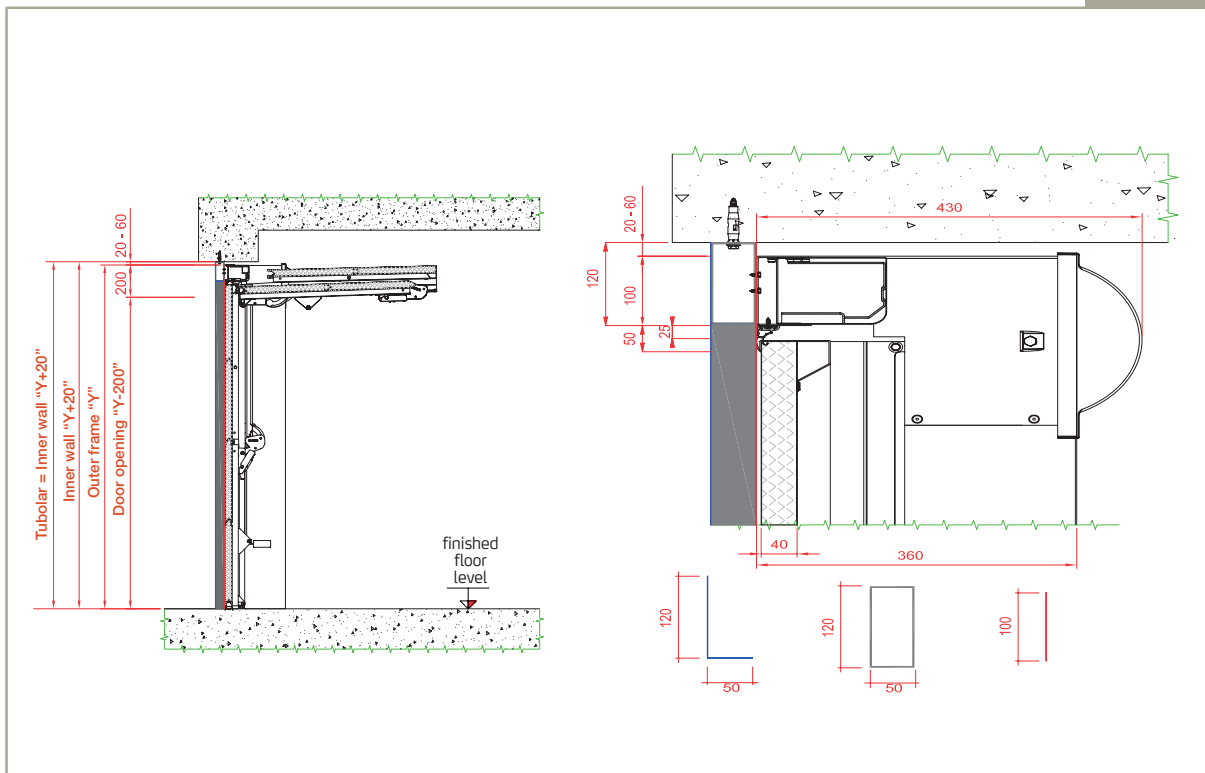

OVERLAP DOOR CLEARANCE

measures in mm

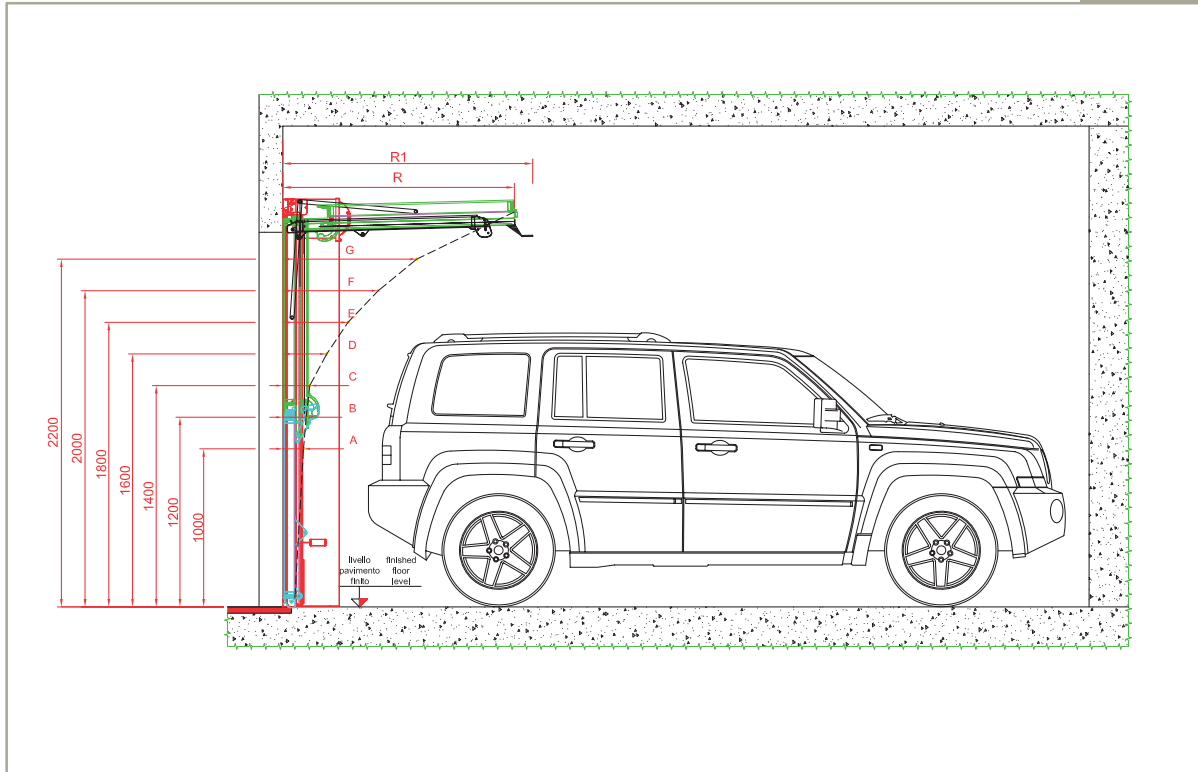

outer frame	door opening	A	B	C	D	E	F	G	R	R1
		1000	1200	1400	1600	1800	2000	2200		
2130	1930	149	194	319	487	725	/	/	1270	1350
2180	1980	147	186	300	460	685	/	/	1320	1400
2230	2030	145	177	281	432	646	/	/	1370	1450
2280	2080	142	169	261	405	606	/	/	1420	1500
2330	2130	140	160	242	377	566	776	/	1470	1550
2380	2180	138	158	227	357	536	741	/	1520	1600
2430	2230	137	155	213	338	505	706	/	1570	1650
2480	2280	135	153	198	318	475	670	/	1620	1700
2530	2330	133	150	183	298	444	635	896	1670	1750
2580	2380	131	148	170	278	412	603	847	1495	1575
2630	2430	130	147	168	272	405	590	820	1545	1625
2680	2480	129	146	166	267	399	577	793	1595	1675
2730	2530	128	144	165	262	394	564	766	1645	1725
2780	2580	127	143	163	257	388	551	739	1695	1775
2830	2630	127	142	162	253	383	539	726	1745	1825
2880	2680	126	141	160	249	377	527	714	1795	1875
2930	2730	126	140	159	245	372	514	701	1845	1925
2980	2780	125	139	157	241	366	502	688	1895	1975

OVERBAS DOOR CLEARANCE - Protruding

measures in mm

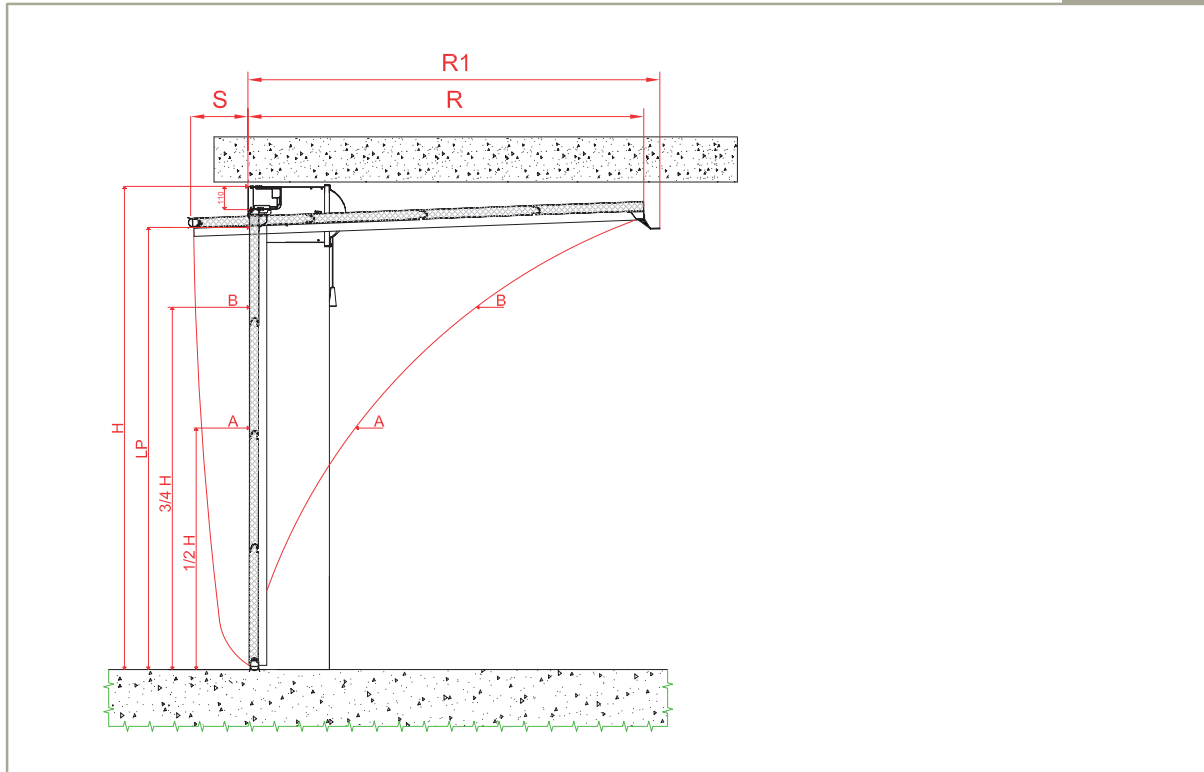

H	A-A	1/2 H	B-B	3/4 H	S	R	R1	LP*
1980	360	990	860	1480	190	1660	1740	1735
2030	360	1015	860	1520	190	1710	1790	1785
2080	360	1040	860	1560	240	1710	1790	1830
2130	360	1065	860	1600	240	1760	1840	1880
2180	360	1090	860	1630	290	1760	1840	1925
2230	360	1115	860	1670	290	1810	1890	1975
2280	360	1140	860	1710	340	1810	1890	2020
2330	360	1165	860	1750	340	1860	1940	2070
2380	360	1190	860	1790	390	1860	1940	2115
2430	360	1215	860	1820	390	1910	1990	2165
2480	360	1240	860	1860	440	1910	1990	2210
2530	360	1265	860	1900	440	1960	2040	2260
2580	360	1290	860	1940	490	1960	2040	2305
2630	360	1315	860	1970	490	2010	2090	2355
2680	360	1340	860	2010	540	2010	2090	2400
2730	360	1365	860	2050	540	2060	2140	2450
2780	360	1390	910	2090	590	2060	2140	2495
2830	360	1415	910	2120	590	2110	2190	2545
2880	360	1440	910	2160	640	2110	2190	2590
2930	360	1465	910	2200	640	2160	2240	2640
2980	360	1490	910	2230	690	2160	2240	2695

*Con portina LP diminuisce di 20mm

OVERBAS DOOR CLEARANCE - Not protruding

measures in mm

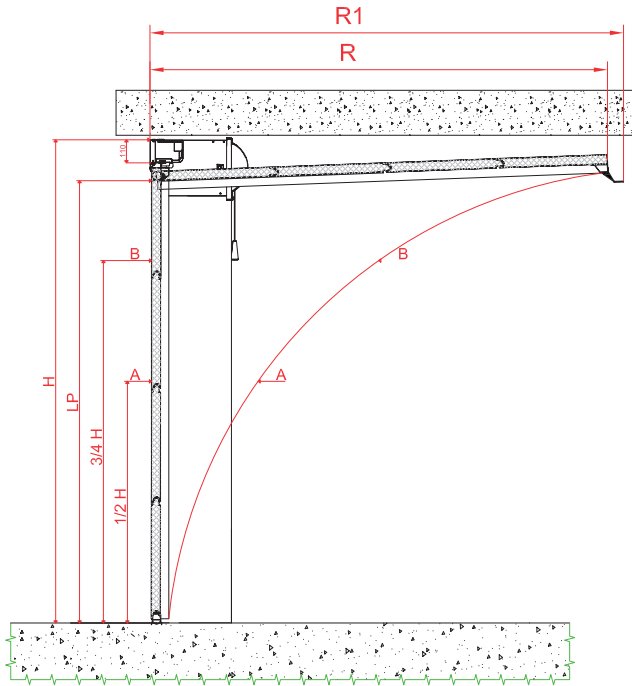

H	A-A	1/2 H	B-B	3/4 H	R	R1	LP*
1980	560	990	1050	1480	1930	2010	1685
2030	570	1015	1075	1520	1980	2060	1735
2080	580	1040	1100	1560	2030	2110	1785
2130	590	1065	1125	1600	2080	2160	1835
2180	600	1090	1150	1630	2130	2210	1885
2230	610	1115	1175	1670	2180	2260	1935
2280	620	1140	1200	1710	2230	2310	1985
2330	630	1165	1225	1750	2280	2360	2035
2380	640	1190	1250	1790	2330	2410	2085
2430	650	1215	1275	1820	2380	2460	2135
2480	660	1240	1300	1860	2430	2510	2185
2530	670	1265	1325	1900	2480	2560	2235
2580	680	1290	1350	1940	2530	2610	2285
2630	690	1315	1375	1970	2580	2660	2335
2680	700	1340	1330	2010	2600	2710	2385

*Con portina LP diminuisce di 20mm

STANDARD FEATURES

- Frame made by 2mm thick metal sheets of galvanized steel, lacquered white RAL 9016 alike/ RAL 7016.
- Lateral double counterweight system.
- Leaf made by sandwich panels 40 mm thick in double sheet of galvanized steel with polyurethane foam, horizontally oriented and mechanically joined.
- Bottom and perimeter sealing in EPDM rubber antientrapment, water and wind proof.
- Anti-entrapment perimeter seal in EPDM rubber, water and wind proof.

TECHNICAL SPECIFICATIONS

- Sectional garage door with door opening in 2 overlapping sections (OVERLAP)
- Thermal transmittance of the door **U=1,5 W/m²K** (value obtained for a door without windows and grids with behind wall installation).
- Excellent performance in terms of acoustics insulation and air/water/wind resistance.
- Motor OverMotion hidden inside the headbar. Receivers and remote controls are not included (optionals). In case there is not a secondary access to the garage, it is compulsory to order a handle.

Delta Overlap dealer:

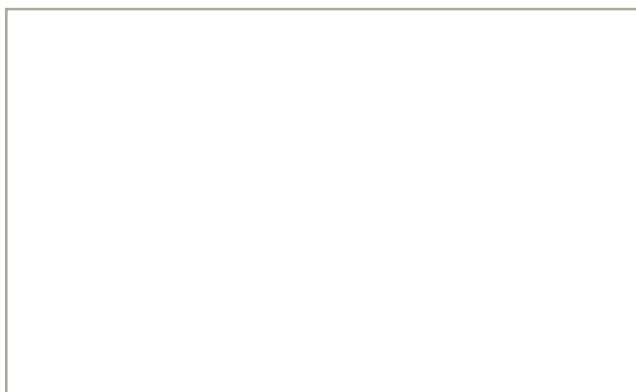

WARRANTY

In addition to the 2-years legal warranty, DELTA OVERLAP supports its customers over time offering them an additional coverage period for a total of:

10 years
on metal parts

5 years
on external panel surface of Plana Model
and Woodstyle plus surface

in accordance with the recommendations in the Delta Overlap sale conditions and in the installation and owner's manual.



DELTAOVERLAP SRL in order to improve the quality of its doors, reserves the right to make changes to its products at any time, to improve customers satisfaction. The images in this brochure are for the purposes of representing the product and are purely indicative and not binding .

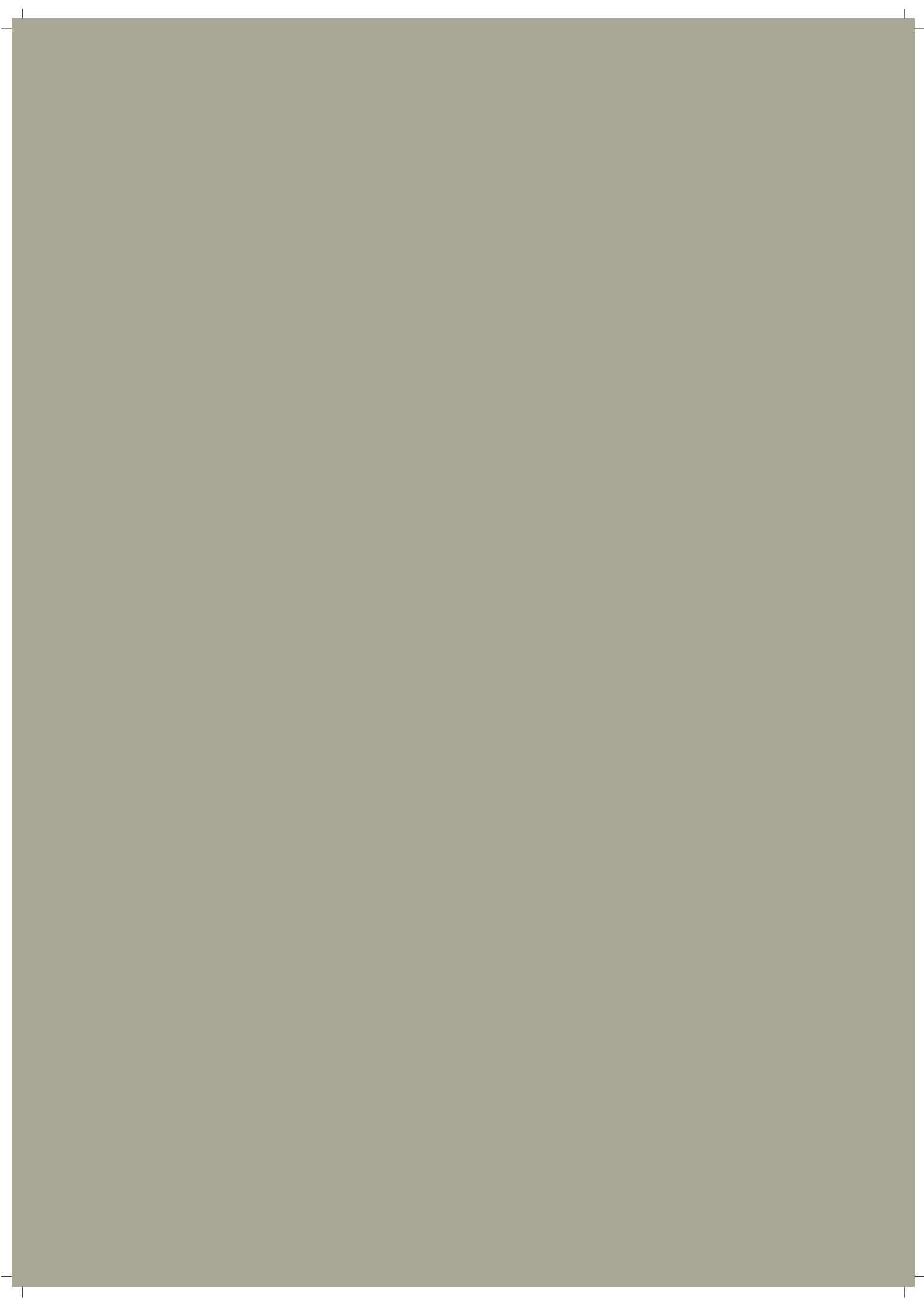



DELTA OVERLAP srl
Legal headquarter:
Via Albertini, 26
60131 Ancona
Tel. +39 071 9033455
Fax +39 071 9033459
Production site:
Zona Industriale Loc. Porrara
83054 Sant'Angelo dei Lombardi (AV)
info@deltaoverlap.com

www.overlapgaragedoors.com