



# Timber Internal Doors

New decors and colours for the Duradecor surface finish







## CONTENT

4	Hörmann brand quality
6	Good reasons to try Hörmann
12	BaseLine
18	DesignLine
24	DesignLine Georgia / Vermont / Carolina
30	TechnicLine
34	Door operator PortaMatic
36	GlassLine
38	Glazings
39	Glazing cut-outs / side elements / transom lights
40	Sliding door versions
42	Door leaf versions
44	Panelled versions
46	Handle sets
48	Handles for sliding doors / fittings for all-glass doors
50	Surface finishes
54	Overview table
56	Technical data
59	Hörmann product range

Some of the doors shown are equipped with optional extras and do not always correspond to the standard models. The surface finishes and colours shown are subject to the limitations of the printing process and cannot be regarded as binding. All colours based on RAL.

All rights reserved. No part may be reproduced without our prior permission. Subject to changes.

## Discover a new feeling of home: high quality timber internal doors

Our home is the centre of our life, our safe haven, our oasis of well-being.

As a family business, this spurs us on to provide products made in Germany to give you that special feeling of being at home. Our high quality timber internal doors contribute to this and provide your home with that extra cosy feeling.

Whether classic or modern, white lacquer or beech, with glass elements or stainless steel embellishments – Hörmann offers you the timber internal door that suits you and your furnishings perfectly.





“A good reputation must be earned.”

August Hörmann

In keeping with the tradition started by the company's founder, the name Hörmann delivers brand name quality with extensive product expertise. The family business has over 75 years of experience as a construction component specialist and sees itself as your partner from the very beginning of building and renovation projects. It's no surprise that Hörmann is one of Europe's most successful internal door providers. All this makes Hörmann timber internal doors a reassuring purchase.



## 1 Quality products from Germany

The door and frame design are developed by Hörmann in-house. The doors are manufactured based on quality, environmental, energy and workplace safety management guidelines acc. to DIN EN ISO 9001, 14001, 50001 and BS OHSAS 18001. In addition, our highly qualified employees work intensively on new products, continual further developments and improvements to details. Patents and unique products on the market are the result of this.



## 2 Internal doors for generations

We are convinced of our products and our uncompromising quality assurance. You can enjoy a Hörmann timber internal door for years to come because you are literally choosing a “door for life”.



## 3 An eye on the future

Hörmann is setting a good example. This is why, since 2013, the company has obtained 40 % of its required energy from green sources and will continue to increase this percentage. At the same time, many tonnes of CO<sub>2</sub> are saved each year thanks to the introduction of an intelligent and certified energy management system. And last but not least, Hörmann offers products for sustainable construction. Find out more about Hörmann’s environmental activities in the “We think green” brochure.

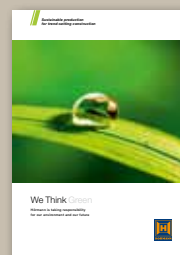



## 4 Door leaf and frame versions

### **Custom combinations:**

A rebated door leaf with rounded edges and a frame with rounded edges create a harmonious Softline look **1**. The same combination with angular edges results in clear lines (no image). The flush-closing door leaf and a frame with angular edges give your door a practically flush-fitting appearance **2**.

### **High quality door leaf:**

Available with four different door leaf inserts – from a simple honeycomb insert up to a high-quality solid chipboard.

### **Sturdy timber frame:**

Consists of an extra sturdy 25-mm-thick jamb lining. Particularly robust MDF boards give the decorative edges and rebate cladding a smooth surface.





## 5 Steel profile frame VarioFix

For the new Hörmann steel profile frame VarioFix, wall tolerances of up to 20 mm are no longer a problem **3**: The adjustable decorative rebate compensates for different wall thicknesses in renovation and new construction projects. As easy to fit as a timber frame, the steel profile frame is additionally distinguished by its long service life and attractive design. Only VarioFix offers high resistance and an elegant shape without visible foldback coupled with the fitting principle of timber frames.



## 6 Barrier-free living: door operator PortaMatic

Are you physically disabled or would you simply like more convenience? Then equip your timber internal doors with the innovative door operator PortaMatic. This allows you to automatically close and open the doors via a hand transmitter or switch, improving your quality of life. For more information, see from page 34.



## 7 Extremely impact-resistant: Duradecor surface

The high-quality surface will delight you: Duradecor captivates due to features such as heat resistance, robustness and impact resistance, which combine to ensure a long service life.



## 8 See and touch: Duradecor texture

The finely textured surfaces allow you to feel what you see. A wood grain texture is embossed into the door leaf, making the characteristic wood structure of the Duradecor texture surface tangible. In the synchronous texture, the wood grain matches the printed surface finish exactly.

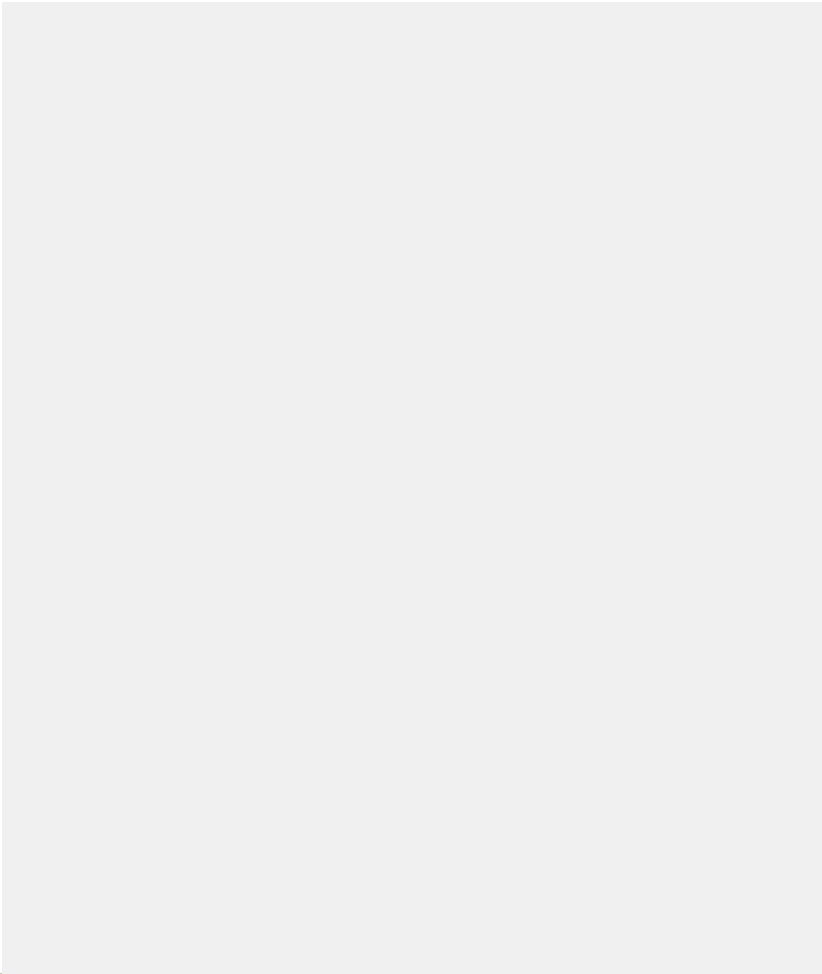

## 9 High-class and smooth: painted surface finishes

Timber internal doors with white painted surfaces have an especially classic and high-quality effect. The Hörmann paint coating on a white base plate ensures a uniform surface with a rich, vibrant colour.

## 10 All natural: real wood veneer

Hörmann real wood veneers are produced from high-quality real timber and are truly unique. An environmentally-friendly protective paint ensures that you can enjoy your real wood door for a long time.



## Plain, chic, timeless: BaseLine

Would you like a timelessly elegant internal door with a welcoming character for your home? Then the door models in the BaseLine series offer you the perfect selection. The solid door leaf in a flush or rebated version – combined with your preferred surface – harmonises wonderfully with your style. This allows you to create a comfortable and relaxing atmosphere.





**BaseLine**  
**Duradecor Traffic white RAL 9016, double-leaf**  
Flush version with concealed hinges



**BaseLine**  
**Duradecor White**  
**Parchment with glazing**  
**cut-out LA 9**  
Rebated version



**BaseLine**  
**Duradecor White Ash**  
Rebated version



**BaseLine**  
**Duradecor Italian Acacia**  
Flush version



**BaseLine**  
**Duradecor Canadian**  
**Maple with glazing cut-**  
**out DIN Rebated version**



**BaseLine**  
**Duradecor French Beech**  
Rebated version



**BaseLine**  
**Duradecor White Oak**  
**with glazing cut-out LA 2**  
Rebated version



**BaseLine**  
**Duradecor Grey Oak**  
Rebated version



**BaseLine**  
**Duradecor synchronous texture Quartz Oak**  
Flush version



**BaseLine**  
**Duradecor synchronous texture Basalt Oak**  
Flush version



**BaseLine**  
**Duradecor synchronous texture Fire Oak**  
Flush version



**BaseLine**  
**Duradecor texture Wild Oak**  
Rebated version



**BaseLine**  
**Duradecor texture Raw Oak**  
Rebated version



**BaseLine**  
**Real wood veneer Beech**  
Rebated version



**BaseLine**  
**Real wood veneer White Oak**  
Rebated version



**BaseLine**  
**Real wood veneer Maple with glazing cut-out LA 9**  
Rebated version



**BaseLine**  
**Lacquer Traffic white RAL 9016**  
Rebated version



**BaseLine**  
**Anthracite grey paint RAL 7016 with glazing cut-out LA 11, double-leaf**  
Flush version with concealed hinges



**BaseLine**  
**Lacquer Light grey RAL 7035**  
Rebated version



**BaseLine**  
**Lacquer Pure white RAL 9010**  
Rebated version







## Discover your dream door: DesignLine

Create the door of your dreams with DesignLine. Upmarket lacquer surfaces, natural wood veneers and robust Duradecor surfaces in exclusive designs satisfy the highest demands when it comes to style. Whether you choose a rebated or flush door leaf or style elements like surface-mounted embellishments or recessed grooves, the DesignLine models allow you to attractively outfit your home according to your taste.



## Plain / Steel: we are dedicated to detail

Subtle embellishments transform your timber internal door into a stylish eye-catcher and satisfy the highest design demands.

For the style Plain 27-7, embellishments **1** with a brushed matt stainless steel look are inlaid flush-fitting in the door leaf, creating an elegant contrast.

Surface-mounted aluminium embellishments **2** on the door leaf give the Steel styles timelessly elegant contours that fascinate design fans.

The Steel styles and the style Plain 27-7 are available in all decors of the extremely impact-resistant Duradecor\* surface.

## Inlay: harmonious combinations

A small detail with a major effect: the inlaid pilaster strips **3** in Maple or Beech are the highlight of the door style Inlay 26. They fit flush to the door leaf, resulting in a harmonious overall view. The styles Inlay 2 and Inlay 12 in alternating grain patterns provide the door leaf with a unique look. All Inlay styles are available in the real wood veneers Maple, Beech and White Oak.

## Groove: the icing on the cake

Recessed grooves are the special feature of the Groove door styles **4**. They are precision milled in the door leaf and then coated with high-quality paint. This results in elegant door styles with white surfaces that are a highlight in any room.

The door leaf version with rounded edges showcases the grooves in a particularly elegant manner.



Flush-fitting inlaid embellishment in stainless steel look for the style Plain 27-7



Surface-mounted aluminium embellishment for the Steel styles



Inlaid pilaster strips in the door style Inlay 26

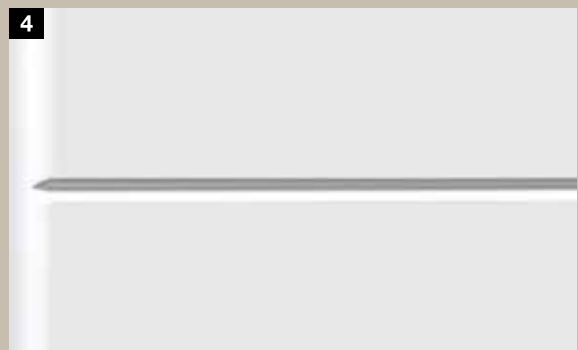

Recessed grooves in the Groove door styles



**Plain 27-7**  
**Duradecor Traffic**  
**white RAL 9016**  
Rebated version



**Steel 14**  
**Duradecor Traffic**  
**white RAL 9016**  
Flush version with  
concealed hinges



**Steel 27**  
**Duradecor Traffic**  
**white RAL 9016**  
Rebated version



**Rail 1**  
**Duradecor**  
**White Parchment**  
**Design glass 2**  
**with matt sections**  
Rebated version



**Steel 20**  
**Duradecor Traffic**  
**white RAL 9016**  
Rebated version



**Rail 2**  
**Duradecor White Ash**  
**Satinato glass**  
Rebated version



**Plain 27-7**  
**Duradecor Italian Acacia**  
Flush version



**Steel 14**  
**Duradecor Grey Oak**  
Flush version with  
concealed hinges



**Steel 20**  
**Duradecor French Beech**  
Rebated version



**Rail 2**  
**Duradecor French Beech**  
**Satinato glass**  
Rebated version



**Steel 27**  
**Duradecor Canadian**  
**Maple**  
Rebated version



**Rail 1**  
**Duradecor White Oak**  
**Design glass 2**  
**with matt sections**  
Rebated version



**Inlay 26**  
**Real wood veneer Beech**  
Flush version



**Inlay 2**  
**Real wood veneer**  
**White Oak**  
Rebated version



**Rail 1**  
**Real wood veneer**  
**White Oak**  
**Satinato glass**  
Rebated version



**Inlay 12**  
**Real wood veneer Maple**  
Flush version with  
concealed hinges



**Rail 2**  
**Real wood veneer Maple**  
**Design glass 2**  
**with matt sections**  
Rebated version



**Groove 15**  
**White lacquer**  
Rebated version



**Groove 13**  
**White lacquer**  
Rebated version



**Rail 1**  
**White lacquer**  
**Design glass 2**  
**with matt sections**  
Rebated version



**Groove 20**  
**White lacquer**  
Rebated version



**Rail 2**  
**White lacquer**  
**Satinato glass**  
Rebated version





## Welcome to the perfect country style

Classic door styles create a comfortable and homely atmosphere. With the DesignLine, Hörmann offers exclusive doors in the high-quality Duradecor, real wood veneer and lacquer surfaces. This quality craftsmanship made in Germany ensures an authentic door look and a long service life.



## Georgia: high-quality details, elegant appearance

For the perfect country look, we recommend the exclusive Georgia door styles. The high-quality profile strip **1** is inlaid into grooves in the door frame using traditional carpentry techniques, lending these styles an elegant appearance. The Georgia door styles are available in all Duradecor\*, real wood veneer and lacquer surfaces.



Inlaid profile strip for the Georgia door styles.  
For more information, see pages 44 – 45.

## Vermont: decorative contrast for more cosiness

The Vermont door styles radiate classic elegance. They are characterised by a profile strip **2** that is surface-mounted on the smooth door leaf, creating a comfortable contrast. These door styles are available in all Duradecor\* designs.



Surface-mounted profile strip for the Vermont door styles.  
For more information, see pages 44 – 45.

## Carolina: beauty that is more than skin deep

The Carolina doors have a clean, classic look. The panel frames are created by an embossed profile **3** in the door leaf. A paint coating on a white base plate gives the styles a smooth, brilliant colour surface.



Embossed profile for the Carolina door styles.  
For more information, see pages 44 – 45.



**Georgia 1**  
**Duradecor Traffic**  
**white RAL 9016**  
**with glazing cut-out**  
Rebated version



**Georgia 2**  
**Duradecor Traffic**  
**white RAL 9016**  
Rebated version



**Georgia 4**  
**Duradecor White Ash**  
Rebated version



**Georgia 1**  
**Duradecor French Beech**  
Rebated version



**Georgia 2**  
**Duradecor Italian Acacia**  
Rebated version



**Georgia 4**  
**Duradecor**  
**Canadian Maple**  
Rebated version



**Georgia 1**  
**Real wood veneer Beech**  
Rebated version



**Georgia 2**  
**Real wood veneer White Oak**  
Rebated version



**Georgia 4**  
**Real wood veneer Maple**  
Rebated version



**Georgia 1**  
**White lacquer**  
Rebated version



**Georgia 2**  
**White lacquer**  
Rebated version



**Georgia 4**  
**White lacquer with glazing cut-out**  
Rebated version



**Vermont 1**  
**Duradecor Traffic white RAL 9016**  
Rebated version



**Vermont 2**  
**Duradecor Traffic white RAL 9016**  
Rebated version



**Vermont 4**  
**Duradecor White Ash**  
Rebated version



**Vermont 1**  
**Duradecor Grey Oak**  
Rebated version



**Vermont 2**  
**Duradecor Italian Acacia**  
Rebated version



**Vermont 4**  
**Duradecor White Oak**  
Rebated version



**Carolina 1**  
**White lacquer**  
Rebated version



**Carolina 4**  
**White lacquer**  
Rebated version



**Carolina 2**  
**White lacquer**  
Rebated version



## A feeling of security for you and your family

Many TechnicLine styles are available as secure apartment entrance doors, and all BaseLine door styles (without glazing cut-out) are available as heavy-duty fire-rated doors. In addition, you have the option of equipping your timber door with special functions, such as a wide-angle camera. This gives you a feeling of security, especially if you are home alone.

### Optional accessories



#### Spyhole

A must for more safety: With a spyhole, you can see who is standing in front of your door at any time without having to open it.



#### Wide angle camera with LCD display

The wide angle camera is a convenient solution for seeing exactly who is outside your door.



#### Electric strike

With the electronic strike catch, you can conveniently open your door via a switch inside the home.



#### Motor lock

Practical, convenient and safe – the motor lock automatically locks your entrance door.

# Apartment entrance doors WAT

## Door styles

- BaseLine without glazing cut-out
- DesignLine: Steel, Plain, Groove, Inlay, Georgia (with contour-milled profile strip) and Vermont.

## Door leaf versions

- Rebated angular
- Rebated round
- Single-leaf

## Function versions



- Climatic class III
- Acoustic rating category 2 (37 dB)



- Climatic class III
- Acoustic rating category 3 (42 dB)



- Climatic class III
- Acoustic rating category 2 (37 dB)
- Security equipment RC 2 (3-point locking with stainless steel lock cover)



Additional locking at bottom in the optional RC 2 security version



Optional VX hinge for increased security



# T30 fire-rated doors

## Door styles

- BaseLine without glazing cut-out

## Door leaf versions

- Rebated angular
- Rebated round
- Single-leaf and double-leaf  
(break-in-resistant RC 2 only for single-leaf)

## Function versions



- T30 fire-retarding (DIN 4102-4)
- Climatic class II (DIN EN 12219)
- Single-leaf: slide rail overhead door closer HDC 35
- Double-leaf: slide rail overhead door closer TS 5000 ISM
- Fire-proof plastic lever handle with short escutcheon



- Fire-retarding (DIN 4102-4)
- Smoke-tight (DIN 18095, DIN EN 1634-01)
- Acoustic rating category 2 (37 dB)
- Climatic class III (DIN EN 12219)
- Single-leaf: slide rail overhead door closer HDC 35
- Double-leaf: slide rail overhead door closer TS 5000 ISM
- Fire-proof plastic lever handle with short escutcheon



- T30 fire-retarding (DIN 4102-4)
- Smoke-tight (DIN 18095, DIN EN 1634-01)
- Acoustic rating category 2 (37 dB)
- Climatic class III (DIN EN 12219)
- Break-in-resistant RC 2 (DIN EN 1627)
- Single-leaf: slide rail overhead door closer HDC 35
- Fire-proof plastic lever handle with short escutcheon
- 3-point locking with stainless steel lock cover



Overhead door closer HDC 35



Fire-protection lever



Hinge system

## Open and close doors effortlessly

With the Hörmann PortaMatic door operator, you can open and close your timber and steel internal doors automatically via hand transmitter or button. Whether you are physically disabled or would simply like more convenience – this technology will make your everyday life easier. The door operator PortaMatic features not only an array of functions and settings, but also minimal power consumption. In addition, the PortaMatic is up to 25 % cheaper than similar door operators.



For further information, see the PortaMatic brochure.



### Senior-friendly residences

Would you like to stay mobile despite physical limitations? The PortaMatic operator for internal doors improves your quality of life by helping you move about your home unaided.

### Convenient living

You can now carry full trays, heavy crates of beverages or your shopping bags into your rooms unhindered. Even if you don't need the automatic door operator PortaMatic for health reasons, you will never want to do without this convenience again – we guarantee it!

### Barrier-free working

Barrier-free working already plays an important role and will continue to gain importance in the future. The PortaMatic door operator can be integrated into all non-public areas at your workplace, thus ensuring more convenience.

### Hygienic door operation

In office buildings, the risk of infection among employees is especially high on doors leading to the lavatory. In combination with a non-contact switch, the PortaMatic door operator provides reliable protection from germs and bacteria, giving you a sense of security.





## For a friendly atmosphere: all-glass doors

Glass doors are not only upmarket and chic, they contribute to an open and friendly design for your home and lend each room a particular charm. Discover the all-glass door that suits you. Available as leaf doors with timber frame or as sliding doors (for more information on sliding door versions, see pages 40 – 41).



**All-glass door  
with frame in Duradecor  
Traffic white RAL 9016  
Design glass 2**



**All-glass door  
with frame in real wood  
veneer White Oak  
Design glass 1**

## Glass elements according to your specifications

You can choose from five different types of glazing to individually design your internal door.

Every glazing style is available for all-glass doors, for all Rail series styles and for all doors with glazing cut-outs. You can customise your internal door with elegant glass elements according to your taste.



Clear glass

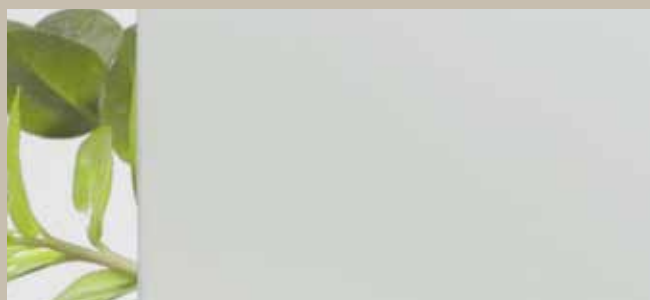

Satinato glass



Mastercarré glass



Design glass 1 with matt lines and clear sections



Design glass 2 with matt sections and clear lines

### Glazing cut-outs

With our selection of glazing cut-outs, you can take your favourite style and make the personalised door of your dreams. You can individually select the glazing style for your glazing cut-outs.

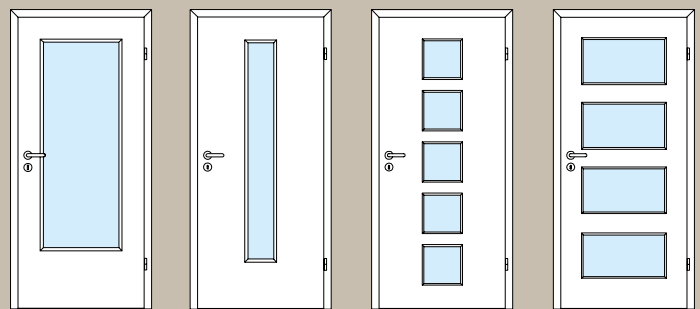

DIN

LA2 centre

LA 5

LA 9

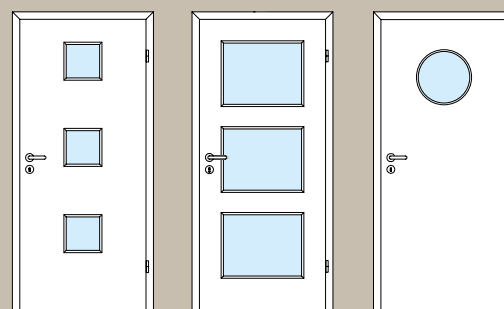

LA 10

LA 11

Round glazing

All door styles in the DesignLines Georgia, Vermont and Carolina are available with glazing in the upper panels.

### Side elements and transom lights

Side elements and transom lights flood your living spaces with light for a special flair. While side elements visually enhance the door sets, transom lights emphasise the room height. Top panels underscore the ceiling-high appearance of the door set.

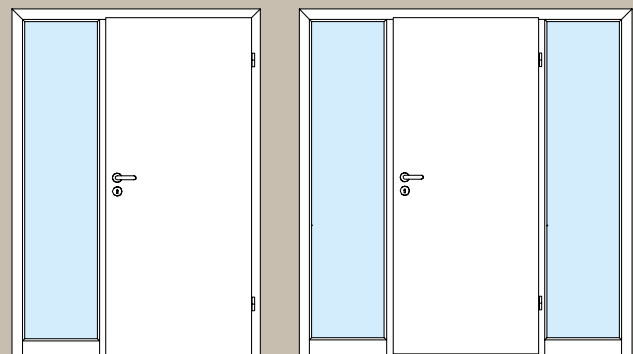

Single-leaf, 1 side element

Single-leaf, 2 side elements

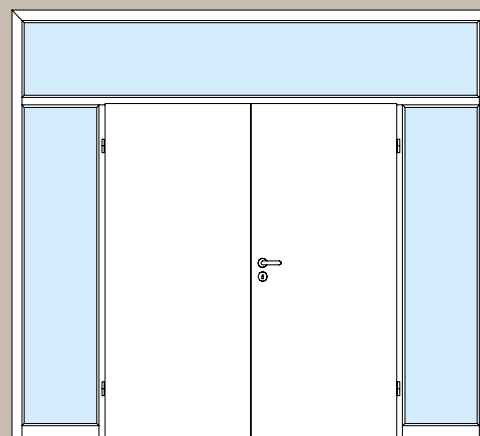

Double-leaf, 2 side elements, 1 transom light

## Our space-saving marvels: sliding doors

Sliding doors open up new possibilities for ideal use of your living space. Hörmann offers sliding door solutions for every living situation. All door styles in BaseLine and DesignLine as well as in GlassLine are available as sliding doors.

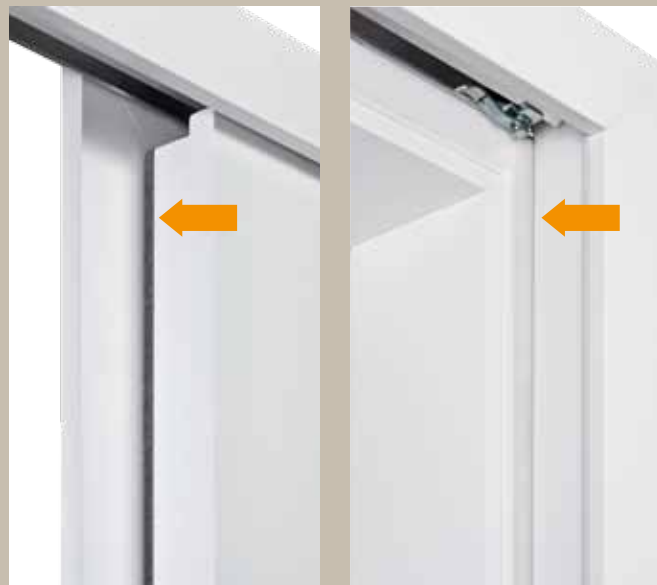

With the brush on the door leaf (figure on left) and the inlet seal in the frame (figure on right), Hörmann sliding doors offer optimal protection against odours, noise and draughts – for even more comfort in your own home.

### Sliding door box type A, for double-leaf sliding doors

When fitted in front of the wall, the door leaf slides on two guide rails mounted in the sliding door box. When fitted running within the wall, the guide rails are fitted in an on-site door pocket in the wall. This eliminates the sliding door box. The wall opening is concealed by the frame.

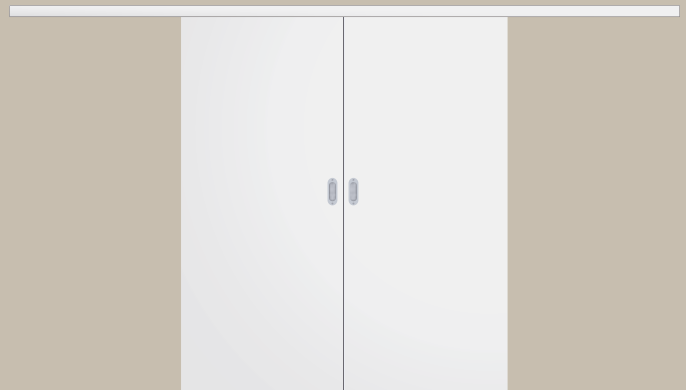

Running in front of the wall: frame, guide rail panelling and door leaf form a harmonious unit



Running within the wall: door leaf is inserted into an on-site door pocket in the wall, the frame completely conceals the wall opening



Sliding door box type C,  
for single-leaf sliding doors

This version also has a vertical stop fitted in the frame. This makes it possible to also have locking functions or other optional extras such as an inlet seal for better protection against odours, noise and draughts.



Running in front of the wall,  
opening towards the left

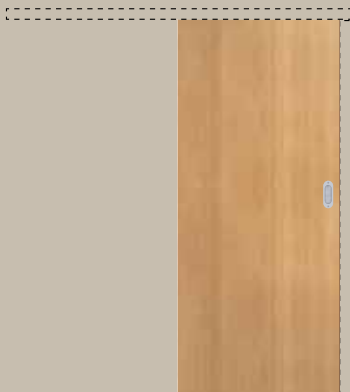

Running within the wall,  
opening towards the left

Sliding door system ■ **NEW**  
Slide Compact / AluTec, for single  
and double-leaf sliding doors

With this system, the door leaves slide in a guide rail profile. The profile in a stainless steel colour can be fitted both in front of the wall and on the ceiling. For a door leaf weight of up to 60 kg, the Slide Compact system is equipped with a SafeClose in order to gently close the door leaves.



Running in front of the wall,  
opening towards the left



Running in front of the wall



Slide Compact  
with glass door



AluTec rail  
with timber door



## Flush version

The flush closing door leaf offers an exclusive door appearance with a practically seamless transition to the frame and emphasises modern home design.

### Hinges



Guide roller  
V 7888 WF 3D  
(as standard)



Concealed 3D hinge  
(optional)

### Lock



Standard: deadlock,  
Class I, lock cover  
in nickel silver



Optional: magnetic  
latch lock

## Rebated version

The rebated version is available in two edge versions. The version with angular edges (no image) creates clear contours while the rebated door leaf with rounded edges provides a harmonic Softline look.



### Hinges



Guide roller  
V 3420 WF  
(as standard)



Guide roller V 4426 WF  
(as standard from 985 mm door  
width for tubular chipboard insert)

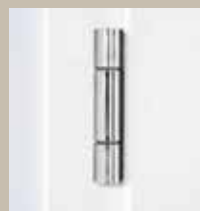

3D hinge VX 100-18  
(optional)



Concealed hinge Pivota FX 2 60 3D  
(optional)

### Lock



Standard: deadlock,  
Class I, lock cover  
in nickel silver

## Our panelled versions in detail

Our panelled doors emphasise a perfect country house style. Whether with a Duradecor surface, in a lacquered version, or as real wood veneer – each individual door satisfies the demands for a tasteful and comfortable home.

You have a choice of styles with intricately inlaid profile strip, classic surface-mounted profile strip or embossed profile.

## Georgia – with inlaid profile strip

During production of the high-quality Georgia door styles, a groove is milled with great care and a profile strip is inlaid in it. This creates a sophisticated door appearance. Georgia is available in all Duradecor\*, real wood veneer and lacquer surfaces and decors.



## Vermont – with surface-mounted profile strip

The surface-mounted profile strip characterises the classic lines of the Vermont door styles. We provide these styles in all the Duradecor\* surface designs.



## Carolina – with embossed profile

In the Carolina styles, the profile is embossed directly into the door leaf and then carefully painted. The Carolina series is available with a white lacquer surface.



## Handle sets to suit every taste

Whether classic or modern, angular or rounded – Hörmann offers you a wide range of elegant and high-quality lever handle sets for the BaseLine, DesignLine and TechnicLine door models.



For an especially elegant door appearance, all lever handles are optionally available in a flush-fitting Planar variant.

### Handles for door leaves



Ala  
Brushed matt stainless steel



Contra  
Brushed matt stainless steel

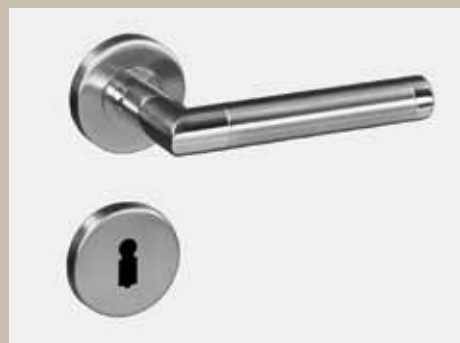

Senso  
Brushed matt stainless steel

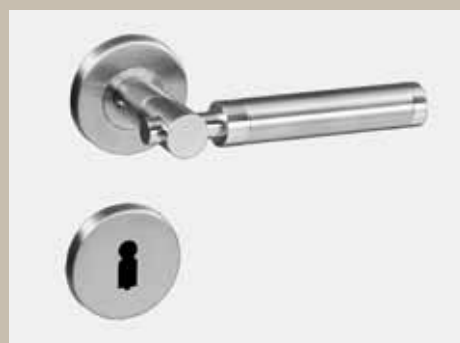

Arundo  
Brushed matt stainless steel

The pictured handles are optionally available in the following versions:



Linea  
Brushed matt stainless steel



PC handle set (cylinder optional)



Deadlock handle set



Tento  
Brushed matt stainless steel



WC handle set



PC lever / knob handle set  
with door knob

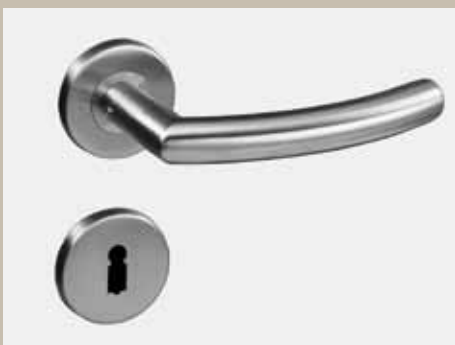

Vallis  
Brushed matt stainless steel



Vento  
Brushed matt stainless steel

# Beautifully shaped handles that are simply impressive

Personalise your sliding door with the handle of your choice. We offer handles for glass doors and timber doors that tastefully complete the look of your sliding door.

## Handles for sliding doors



Handle recess, oval, matt stainless steel (for timber doors)



Handle recess, round, matt stainless steel (for timber doors)



Handle recess, angular, matt stainless steel (for timber doors)

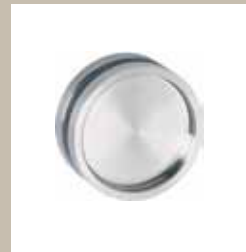

Handle recess, round, closed, matt stainless steel (for glass doors)



Handle recess, angular, closed, matt stainless steel (for glass doors)



Handle bar pair Basic, round, Ø 25 mm, 400 mm length, matt stainless steel



Handle bar pair Basic, angular, 500 mm length, matt stainless steel



Handle bar pair Combi, push bar with one-sided handle plate, 400 mm length, matt stainless steel



For sliding doors that run within the wall, you can conceal the door leaf completely in the wall with a trip handle. The handle springs out at the press of a button, allowing you to close the door.



# Fittings for all-glass doors

For all-glass doors you can choose between a round and an angular fitting set, which can each be combined with one of eight elegant stainless steel lever handles. Each variant is available in a lockable and non-locking version.



Fitting set Aronda



Fitting set Purista



Basica 1



Basica 3



Bellis



Dee



Grafica



Quadriga



Apart



Nala



## Benefit from impressive performance features: Duradecor

With regard to ease of care and robustness, Duradecor cannot be beaten – it is almost as durable as a kitchen countertop.

- Maximum impact resistance
- Hygienic and low-maintenance
- Strong antistatic and colour-fast properties
- Resistant to heat and abrasion
- Stands up to normal household fluids, pastes, etc.

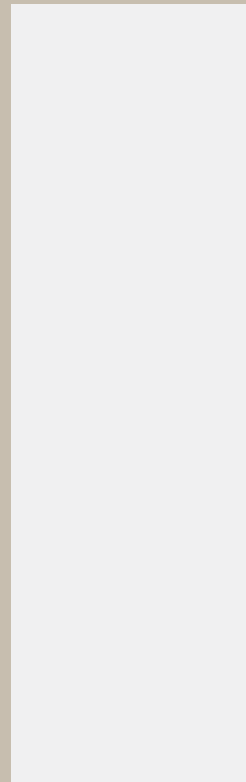

Traffic white  
RAL 9016



Light grey RAL 7035  
■ NEW



Italian Acacia,  
horizontal



Canadian Maple

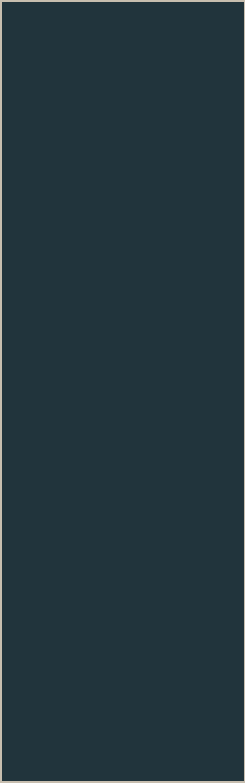

Anthracite grey  
RAL 7016 ■ **NEW**



White Parchment

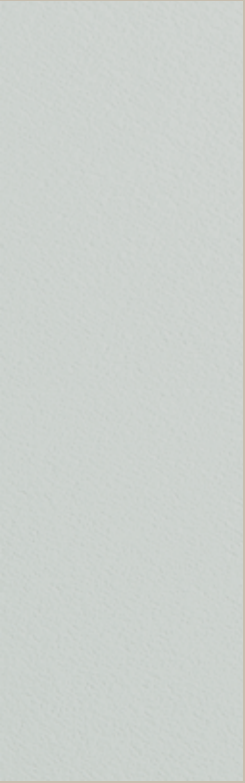

Light Grey  
Parchment ■ **NEW**



White Ash



Italian Acacia



French Beech



White Oak



White Oak, horizontal



Grey Oak

## Duradecor synchronous texture

With the Duradecor synchronous texture surface finish, we have achieved a perfect visual and tactile reproduction of real timber down to the last detail:

- The characteristic wood grain texture is precisely embossed into the door leaf
- The texture matches the printed design exactly
- A perfect reproduction of real timber that's visible and tangible

## Duradecor texture

The Duradecor texture surface has a subtle natural timber character:

- A wood grain texture is embossed into the door leaf, making the characteristic wood structure tangible



52 Quartz Oak

Basalt Oak

Fire Oak

Wild Oak

Red Oak

## Real wood veneer

Just as every tree is different, so too each of our real wood veneers is unique:

- Made of high quality real timber
- Environmentally-friendly protective paint for durable surface protection
- Natural wood grain
- Long-lasting quality



Maple



Beech



White Oak

## Lacquer

Find out about the high-quality Hörmann lacquer surface finish:

- Smooth surface
- Rich, vibrant colour
- Paint coating on a white base plate

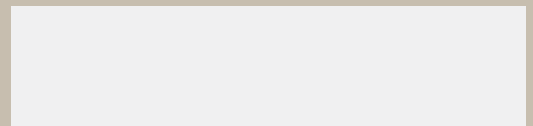

Traffic white RAL 9016

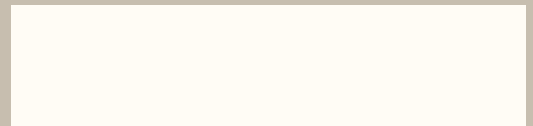

Pure white RAL 9010

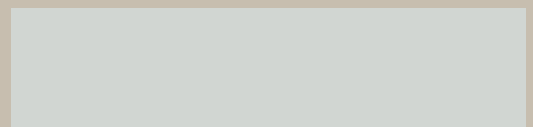



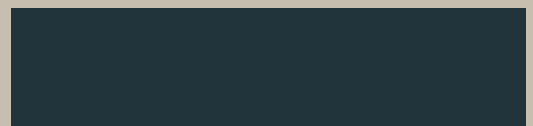











Light grey RAL 7035



Anthracite grey, RAL 7016

Door styles

	BaseLine	DesignLine Steel	DesignLine Groove	DesignLine Inlay	DesignLine Rail	DesignLine Georgia	DesignLine Vermont	DesignLine Carolina	GlassLine	
<b>Surface finishes</b>										
<b>Duradecor</b>										
Rebated angular		●	●	-	-	●	●	●	-	-
Rebated round		●	●	-	-	●	●	●	-	-
Flush angular		●	●	-	-	●	●	●	-	-
<b>Duradecor synchronous texture</b>										
Rebated angular		●	-	-	-	-	-	-	-	-
Rebated round		●	-	-	-	-	-	-	-	-
Flush angular		●	-	-	-	-	-	-	-	-
<b>Duradecor texture</b>										
Rebated angular		●	-	-	-	-	-	-	-	-
Rebated round		-	-	-	-	-	-	-	-	-
Flush angular		●	-	-	-	-	-	-	-	-
<b>Real wood veneer</b>										
Rebated angular		●	-	-	●	●	●	-	-	-
Rebated round		●	-	-	●	●	●	-	-	-
Flush angular		●	-	-	●	●	●	-	-	-
<b>Lacquer</b>										
Rebated angular		●	●	●	-	●	●	-	-	-
Rebated round		●	●	●	-	●	●	-	●	-
Flush angular		●	●	●	-	●	●	-	-	-

## Door leaf insert

Honeycomb insert	Tubular chipboard spacers	Tubular chipboard plate	Solid chipboard
•	-	•	•
-	•	•	•
-	-	•	•
-	-	•	•
-	-	•	•
-	-	•	•
-	-	•	•
-	-	•	•
-	-	•	•
-	•	•	•
-	•	•	•
-	•	•	•
-	-	•	•
-	•	•	•
-	•	•	•



### Honeycomb insert

The honeycomb insert retains its shape and has an excellent price-performance ratio.



### Tubular chipboard spacers

The door leaf insert consists of individual spacers that are arranged in the best possible layout. This causes the door leaf to be especially sturdy and suitable for heavy wear.



### Tubular chipboard plate

The solid plate with horizontal tubes gives door leaves high surface stability. These high-quality internal doors are suitable for even heavier wear.



### Solid chipboard

The high-quality solid chipboard door leaves have the highest leaf rigidity and are suitable for especially heavy wear. Doors with glazing cut-outs are available with solid chipboard as standard.

Technical data

**Door leaf**

- Approx. 40 mm thick (TechnicLine approx. 46 mm thick)
- Frame construction made of solid timber / timber material with additional frame reinforcement, can be shortened by 25 mm at bottom
- For double-leaf doors: with counter rebate\*
- Climatic class I (TechnicLine climatic class III) duty category N to S (according to version)
- Pre-hanged according to DIN 18101
- Suited for timber profile frames or standard frames made of steel

**Frame**

- Rebate cladding 16 x 60 mm, mitred and firmly glued to the jamb lining. 16 x 80 mm on request
- Jamb lining made of 25 mm chipboard, rebate cladding and decorative edge made of 12 MDF boards
- Decorative edge 16 x 60 mm, optionally 16 x 80 mm
- Adjustable for wall thickness - 5 mm / + 15 mm
- Sound-absorbing seal inserted at the factory, mitred

Vertical view

**Rebated**

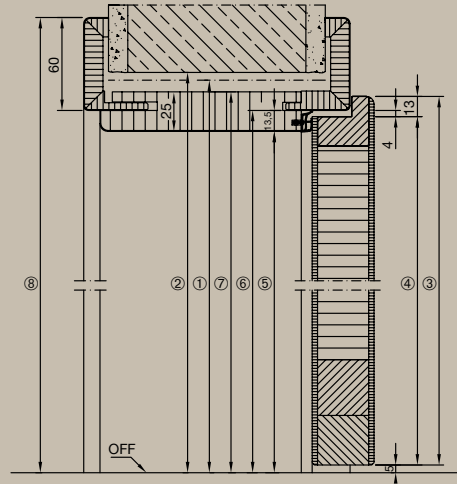

**Flush**

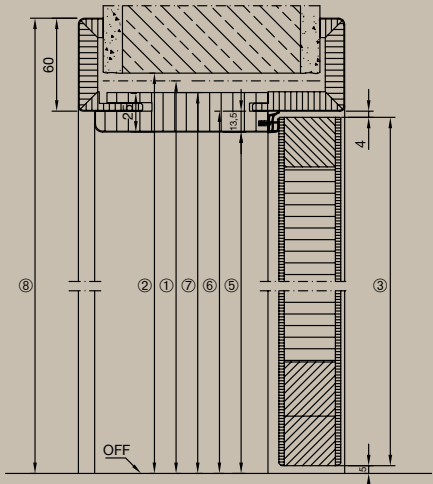

		1875	2000	2125	2250
<b>1</b> Nominal size height		1875	2000	2125	2250
<b>2</b> Wall opening		1880	2005	2130	2255
<b>3</b> Overall door leaf dimension	Rebated	1860	1985	2110	2235
	Flush	1847	1972	2097	2222
<b>4</b> Leaf rebate dimension		1847	1972	2097	2222
<b>5</b> Clear passage dimension		1843	1968	2093	2218
<b>6</b> Frame hold dimension		1856	1981	2106	2231
<b>7</b> Overall lining dimension		1868	1993	2118	2243
<b>8</b> Overall cladding dimension for 60 mm cladding (for 80 mm cladding 20 mm)		1916	2041	2166	2291

Frame types

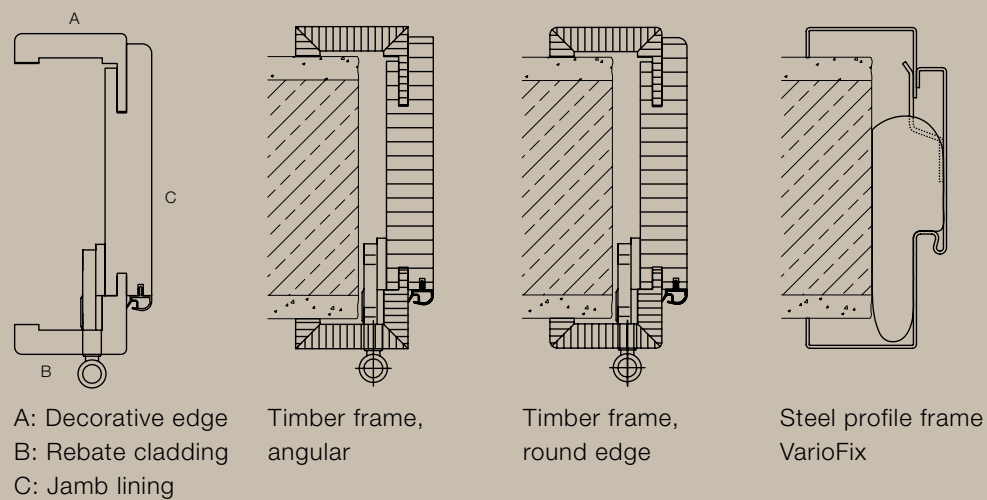



## Horizontal view – single leaf

### Rebated

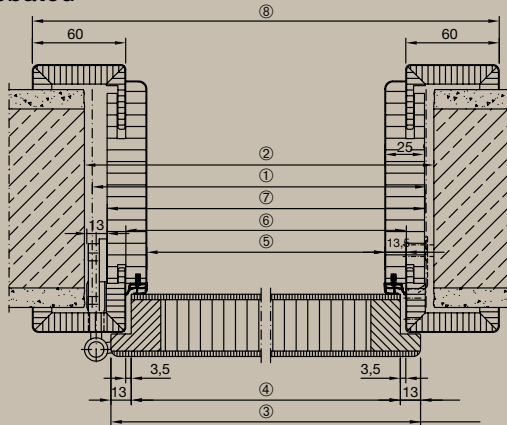

### Flush

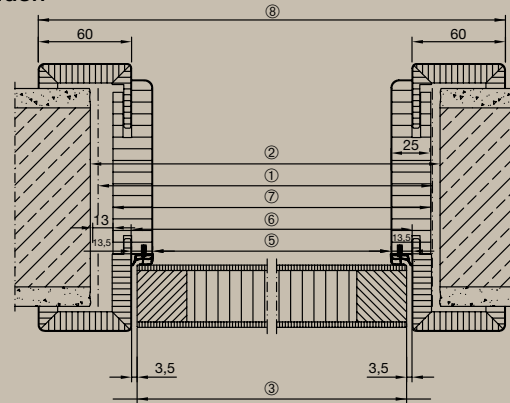

		625	750	875	1000	1125	1250
<b>1</b> Nominal size width		625	750	875	1000	1125	1250
<b>2</b> Wall opening		635	760	885	1010	1135	1260
<b>3</b> Overall door leaf dimension	Rebated	610	735	860	985	1110	1235
	Flush	584	709	834	959	1084	1209
<b>4</b> Leaf rebate dimension		584	709	834	959	1084	1209
<b>5</b> Clear passage dimension		564	689	814	939	1064	1189
<b>6</b> Frame hold dimension		591	716	841	966	1091	1216
<b>7</b> Overall lining dimension		614	739	864	989	1114	1239
<b>8</b> Overall cladding dimension		711	836	961	1086	1211	1336

## Horizontal view – double leaf

### Rebated

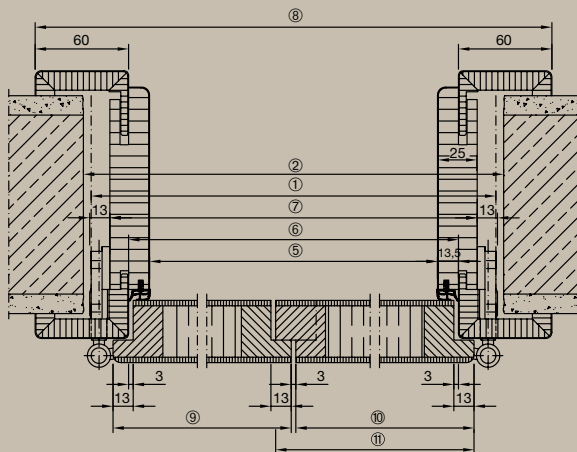

### Flush

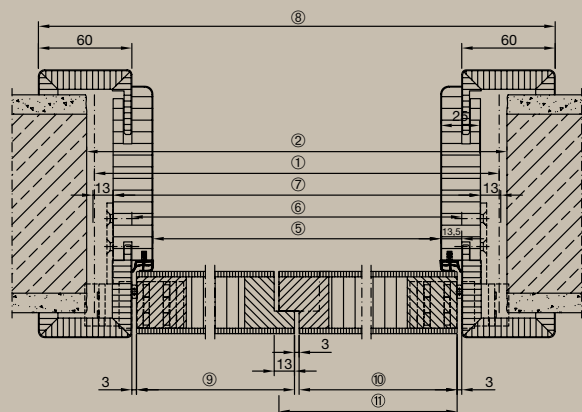

		1250	1375	1500	1750	1875	2000	2250	2500
<b>1</b> Nominal size width		1250	1375	1500	1750	1875	2000	2250	2500
<b>2</b> Wall opening		1260	1385	1510	1760	1885	2010	2260	2510
<b>5</b> Clear passage dimension		1176	1301	1426	1676	1801	1926	2176	2426
<b>6</b> Frame hold dimension		1203	1328	1453	1703	1828	1953	2203	2453
<b>7</b> Overall lining dimension		1226	1351	1476	1726	1851	1976	2226	2476
<b>8</b> Overall cladding dimension		1323	1448	1573	1823	1948	2073	2323	2573
<b>9</b> Overall door leaf dimension Traffic leaf	Rebated	610	735	735	860	985	985	1110	1235
	Flush	597	722	722	847	972	972	1097	1222
<b>10</b> Overall door leaf dimension Fixed leaf with meeting style*	Rebated	610	610	735	860	860	985	1110	1235
	Flush	597	597	722	847	847	972	1097	1222
<b>11</b> Overall door leaf dimension Fixed leaf with counter rebate	Rebated	623	623	748	873	873	998	1123	1248
	Flush	610	610	735	860	860	985	1110	1235

\* Only for Carolina door styles

All dimensions in mm



# Experience Hörmann quality in new construction and modernisation

Hörmann provides an excellent basis for comprehensive planning. Carefully matched solutions offer you the very best in perfectly designed products for every area.

- **Garage doors**

Optimally match your personal architectural style: up-and-over or sectional doors made of steel or timber.

- **Door operators**

Enjoy extra convenience and break-in-resistant security with Hörmann operators for garage doors and entrance gates. You can profit from the convenience of Hörmann door operators in your residential space as well.

- **Entrance doors**

Our comprehensive entrance door ranges include models that fit almost every need and requirement.

- **Timber internal doors**

The high-quality timber internal doors give your home an extra level of comfort and match your personal style perfectly.

- **Steel doors**

Sturdy doors for your entire home, from basement to roof.

- **Frames**

Choose from our comprehensive range of products for new construction, expansion and modernisation.



Garage doors and entrance gate operators



Timber internal doors



Steel doors

# Hörmann: Quality without Compromise



Hörmann KG Amshausen, Germany



Hörmann KG Antriebstechnik, Germany



Hörmann KG Brandis, Germany



Hörmann KG Brockhagen, Germany



Hörmann KG Dissen, Germany



Hörmann KG Eckelhausen, Germany



Hörmann KG Freisen, Germany



Hörmann KG Ichttershausen, Germany



Hörmann KG Werne, Germany



Hörmann Genk NV, Belgium



Hörmann Alkmaar B.V., Netherlands



Hörmann Legnica Sp. z o.o., Poland



Hörmann Beijing, China



Hörmann Tianjin, China



Hörmann LLC, Montgomery IL, USA



Hörmann Flexon LLC, Burgettstown PA, USA

Hörmann is the only manufacturer worldwide that offers you a complete range of all major building products from one source. We manufacture in highly-specialised factories using the latest production technologies. The close-meshed network of sales and service companies throughout Europe, and activities in the USA and China, make Hörmann your strong partner for first-class building products, offering “Quality without Compromise”.

**GARAGE DOORS**  
**OPERATORS**  
**INDUSTRIAL DOORS**  
**LOADING EQUIPMENT**  
**HINGED DOORS**  
**DOOR FRAMES**

