



**GLIDEROL**  
GARAGE DOORS

Opening Doors Around the World®

[www.gliderol.co.uk](http://www.gliderol.co.uk)

# price list February 2013

# garage doors

For your home, your lifestyle...



**GLIDEROL  
GARAGE DOORS**

Opening Doors Around the World®

www.gliderol.co.uk

# Contents

 **GlideRol•a•Door®**  
Light Industrial Roller Door

page 3

 **GlideRol•a•Door®**  
Continuous Sheet Curtain Roller Door

 **GlideRol•a•Door Mini®**  
Continuous Sheet Curtain Roller Door

page 4-5

 **Roll•a•Glide®**  
Insulated Automatic Roller Door

page 6-7

 **Roll•a•Glide Compact®**  
Insulated Automatic Roller Door

 **Roll•a•Glide Manual®**  
Insulated Manual Roller Door

page 8-9

 **Panel•Glide®**  
Sectional Overhead Garage Door

 **Safe•T•Glide®**  
Steel Panel Sectional Overhead Garage Door

 **Insul•Glide®**  
42mm Insulated Steel Panel Sectional  
Overhead Garage Door

page 10-15

**Manufacturers Warranty**

page 16



Made in the UK



**Opening Doors Around the World®**

Gliderol operates the worlds most extensive network of garage door and automation manufacturing companies. Our UK facility is based at Peterlee in County Durham and has been **“opening doors around the world”** for over twenty years. Our reputation is second-to-none for the high quality and outstanding value our products and services represent.



Recommended Retail Price List Tel: 0191 518 0455 Fax: 0191 518 0548  
Effective February 1st 2013 Prices in £ Sterling and Excluding VAT & Delivery

All Gliderol products are CE marked and built within our audited ISO 9001 quality systems.





Series B Height	Curtain Width (Opening width + 100mm)									
	6'-4" 1930mm	7'-4" 2235mm	8'-4" 2540mm	9'-4" 2850mm	10'-4" 3150mm	11'-4" 3450mm	12'-4" 3760mm	14'-4" 4370mm	16'-4" 5000mm	
1201-2100mm	1025	1065	1104	1145	1449	1509	1608	1799	2053	
2101-2400mm	1230	1278	1325	1374	1739	1811	1930	2159	2464	
2401-2700mm	1250	1299	1341	1390	1489	1554	1728	1915	2193	
2701-3000mm	1500	1559	1610	1668	1787	1865	2074	2298	2632	
3001-3300mm	1269	1312	1365	1407	1505	1594	1858	1986	2247	
3301-3600mm	1523	1575	1638	1689	1806	1913	2230	2384	2697	
3601-4200mm	1278	1319	1371	1414	1515	1643	1978	2193	2350	
4201-4800mm	1534	1583	1646	1697	1818	1972	2374	2632	2820	
4801-4900mm	1287	1338	1381	1430	1526	1658	2014	2266	2451	
	1545	1606	1658	1716	1832	1990	2417	2720	2942	
	1341	1390	1443	1493	1596	1729	2081	2350	2553	
	1610	1668	1732	1792	1916	2075	2498	2820	3064	
	1390	1443	1493	1555	1739	1854	2184	2451	2636	
	1668	1732	1792	1866	2087	2225	2621	2942	3164	
	1399	1452	1511	1575	1762	1876	2234	2523	2665	
	1679	1743	1814	1890	2115	2252	2681	3028	3198	
	1443	1503	1564	1627	1801	1948	2318	2595	2780	
	1732	1804	1877	1953	2162	2338	2782	3114	3336	

□ Denotes Plastisol Finish Pricing □ Denotes Laminate Finish Pricing Mahogany woodgrain attracts a 7% surcharge (add to plastisol price)

□ Above red line denotes chain hoist hand operated Door, unless automated with Glidermatic Dual Motor (no chain hoist).  
Below red line denotes door fitted with a 1 to 1 direct chain hoist\*

□ Below blue line denotes door fitted with 4 to 1 reduced chain hoist planetary gears (included in price) & IGDU heavy duty industrial motor required.

Chain hoists are fitted to the left hand side of the door looking out as standard, right hand on request.

**Automation**

Glidermatic Dual Motor (with 2 handsets) (Not remote control)

£425

IGDU Heavy Industrial Motor

£600

SINGLE PHASE POWER REQUIRED

**Options**

Steel panel wrap

£22 per metre (x door width)

Windlock

£66 per pair per metre (x door height)

**Colours**

High grade finishes coat the steel in an attractive leather grain textured coating or high grade laminate - both are highly durable and will simply wipe clean. Mahogany woodgrain attracts a 7% surcharge (add to Plastisol price).

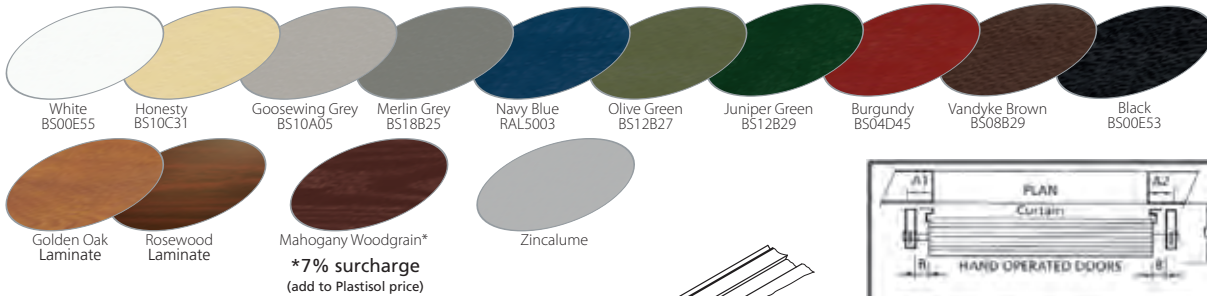

**Ordering & Dimensions**



Features:

1. Roller Door Curtain
2. Spring Assistance
3. Drum Wheel
4. Polyglide
5. Weatherseal
6. Bottom Rail
7. Door Stop/Roller
8. Direct Chain Wheel
9. Chain Guide

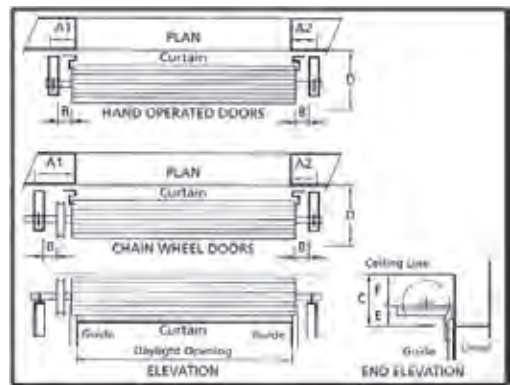
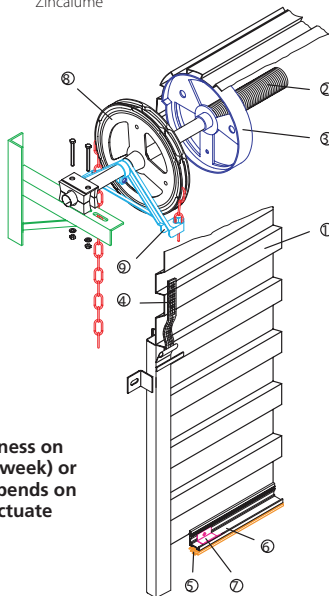

SERIES B INDUSTRIAL	DIMENSION PANEL (Minimum sizes) mm		i	roat	h	f	r
	Slit	Roller					
Hand Operated Up to 2400 high	150	125	50-100	460	540	190	270
Up to 500 high	150	125	50-100	490	560	205	285
Chain Operated Up to 2400 high	225	125	50-100	460	540	190	270
Up to 3000 high	225	125	50-100	490	560	205	285
Over 3000 high	225	125	50-100	530	580	230	300

STANDARD CURTAIN WIDTHS  
1000, 1300, 1600, 1900, 2200, 2800, 3100, 3400, 3700, 3760, 4300, 4370, 5000, 5100

\*CURTAIN WIDTH  
DAYLIGHT OPENING PLUS 100mm

\*\*Typical lead times for doors ordered by close of business on a Tuesday will delivered during the following week (1 week) or the second week following (2 weeks). Delivery day depends on location. These lead times are a guide only and can fluctuate during peak order periods, please seek confirmation.

**Delivery**

Price Includes delivery to Distributor premises on mainland UK. Delivery to site £40 per door.





'A' Series	'A' Series Curtain Width (Curtain width = opening + 50mm)								
	4' 2"	6' 2"	7' 2"	7' 8"	8' 2"	8' 8"	9' 2"	10' 2"	11' 2"
Height	1270mm	1880mm	2185mm	2337mm	2490mm	2650mm	2800mm	3100mm	3400mm
Up to 3' 10"	575	607	684	711	725	761	803	936	1098
1200mm	690	729	821	854	870	914	964	1124	1318
4' 1" to 7'	633	672	711	728	762	802	826	964	1133
1240 to 2135mm	760	807	854	874	915	963	992	1157	1360
7' 1" to 8'	748	777	791	802	838	864	910	1025	1203
2160 to 2440mm	898	933	950	963	1006	1037	1092	1230	1444
8' 1" to 9'	788	835	890	916	966	985	1016	1146	1386
2465 to 2740mm	946	1002	1068	1100	1160	1182	1220	1376	1664
9' 1" to 10'	903	955	998	1057	1079	1102	1118	1260	1594
2770 to 3055mm	1084	1146	1198	1269	1295	1323	1342	1512	1913

'AA' Series	'AA' Series Curtain Width (Curtain width = opening + 100mm)			
	12' 4"	14' 4"	14' 10"	16' 5"
Height	3760mm	4370mm	4521mm	5003mm
Up to 3' 10"	1322	1504	1656	1730
1200mm	1587	1805	1988	2076
4' 1" to 7'	1371	1583	1686	1880
1240 to 2135mm	1646	1900	2024	2256
7' 1" to 8'	1497	1834	1953	2056
2160 to 2440mm	1797	2201	2344	2468
8' 1" to 9'	1675	1940	2058	2160
2465 to 2740mm	2010	2328	2470	2592
9' 1" to 10'	1912	2226	2329	2409
2770 to 3055mm	2295	2672	2795	2891

Mahogany woodgrain attracts a 7% surcharge (add to plastisol price)

Lead Time\*\*  
**1 week**

Denotes Plastisol Finish Pricing

Denotes Laminate Finish Pricing

Above blue line denotes Glidermatic Heavy Duty Motor/  
RW1 ROL•A•MATIC Retrofit Operator.

Below blue line denotes Glidermatic Dual Motor

**Options**

**AUTOMATION**

Glidermatic Heavy Duty Motor (with 2 handsets) £370

Glidermatic Dual Motor (with 2 handsets) £425

A central lock is not supplied on automated doors as standard. Should a lock be required, please state at time of ordering (cost £10 net)

RW1 ROL•A•MATIC Retrofit Operator suitable for most continuous sheet curtain doors (up to 12m<sup>2</sup>). £390

Wireless digital entry key pad (wall mounted) £100

Additional Hand Transmitter

refer to parts price list

External Manual / electric Key Release

refer to parts price list

Hand Transmitter Cradle

refer to parts price list

Hand Transmitter Sun Visor Clip

refer to parts price list

**OPTIONAL EXTRAS**

Mullions (7ft. & 8ft.) £99

Reverse Roll £66

Infill Panels (per linear metre) £36

Steel Panel Wrap per metre (x door width) £22

Windlock per pair per metre (x door height) (AA doors only) £66

**Colours**

High grade finishes coat the steel in an attractive leather grain textured coating or high grade laminate (marked\*) - both are highly durable and will simply wipe clean. Mahogany woodgrain attracts a 7% surcharge (add to Plastisol price).

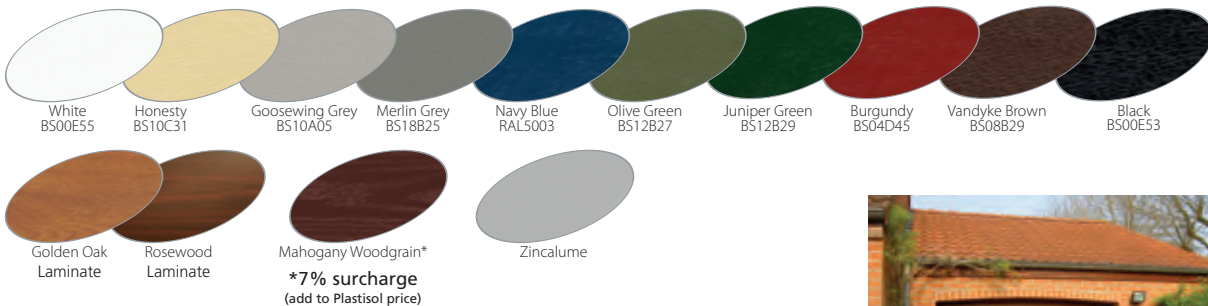

\*\*Typical lead times for doors ordered by close of business on a Tuesday will delivered during the following week (1 week) or the second week following (2 weeks). Delivery day depends on location. These lead times are a guide only and can fluctuate during peak order periods, please seek confirmation.



**Delivery**

Price Includes delivery to Distributor premises on mainland UK. Delivery to site £40 per door.

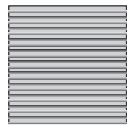

'A' Series		'A' Series Curtain Width (Opening width + 50mm)					
Height	7' 2"	7' 8"	8' 2"	8' 8"	9' 2"	10' 2"	11' 2"
	2185mm	2337mm	2490mm	2650mm	2800mm	3100mm	3400mm
4'1" to 7'	772	783	794	833	865	982	1097
1240 to 2135mm	927	940	953	1000	1038	1179	1317

Denotes Plastisol Finish Pricing     Denotes Laminate Finish Pricing    Mahogany woodgrain attracts a 7% surcharge (add to plastisol price)

**Options**

**AUTOMATION**

RW•1 Retrofit Operator (with 2 handsets)	£390
Wireless digital entry key pad (wall mounted)	£100
Additional Hand Transmitter	refer to parts price list
External Manual / Electric Key Release	refer to parts price list
Hand Transmitter Cradle	refer to parts price list
Hand Transmitter Sun Visor Clip	refer to parts price list

**OPTIONAL EXTRAS**

Infill Panels (per linear metre)	£36
Steel Panel Wrap per metre (x door width)	£22

**Colours**

High grade finishes coat the steel in an attractive leather grain textured coating or high grade laminate (marked\*) - both are highly durable and will simply wipe clean. Mahogany woodgrain attracts a 7% surcharge (add to Plastisol price).

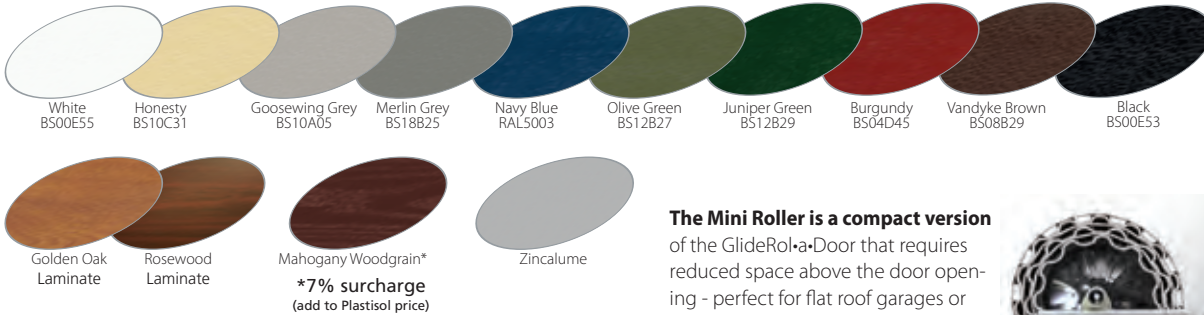

**\*\*Typical lead times for doors ordered by close of business on a Tuesday will delivered during the following week (1 week) or the second week following (2 weeks). Delivery day depends on location. These lead times are a guide only and can fluctuate during peak order periods, please seek confirmation.**

**Ordering & Dimensions**

Glidermatic doors require an extra 20mm side clearance on the side the drive unit is required to be fitted.

Sizes - GlideRol•a•Door up to 5m wide and 3m high.  
GlideRol•a•Door Mini up to 3.4m wide and 2.1m high.

Windlock system - should be specified for double doors in very exposed locations and greater side room clearance is required. For advice and information, speak to our technical department or your supplier.



**The Mini Roller is a compact version** of the GlideRol•a•Door that requires reduced space above the door opening - perfect for flat roof garages or other space restricted garages. The door is available up to 2135mm high and 3400mm wide in all the same finishes and remote control options as its larger brother.

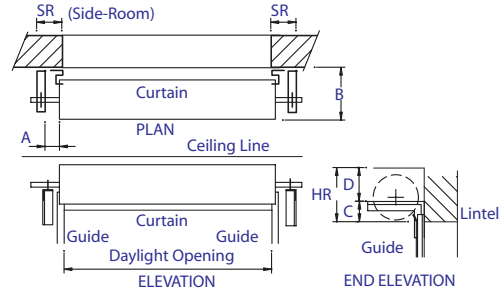
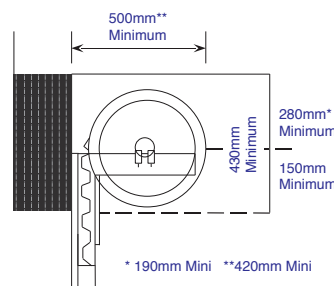
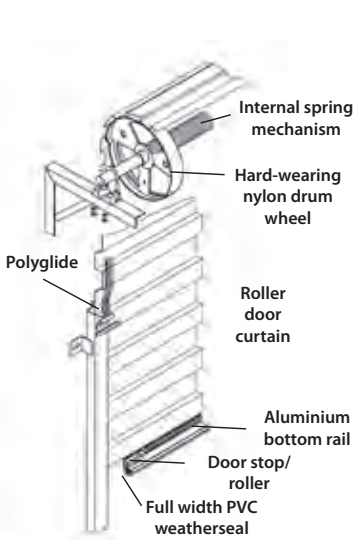

DIMENSION PANEL (minimum sizes) mm							
SERIES A (Hand Operated)	Side Room		Head Room	A	B	C	D
	Resid.A	Resid.AA					
2100 HIGH	90	125	430	25-100	500	150	280
2400 HIGH	90	125	450	25-100	540	160	290
2700 HIGH	90	125	450	25-100	540	160	290
3000 HIGH	90	125	470	25-100	560	170	300
Mini							
2100 HIGH	90	-	340	25-100	420	150	190

If recommended headroom is not available the door may still be installed, required headroom should be maintained (n.b. some loss of opening height will occur and the roll of the door will be visible, but this may be disguised by a fascia).

**Delivery**

Price Includes delivery to Distributor premises on mainland UK. Delivery to site £40 per door.



NO Box		Over Guide Width						
Guide Height	2050mm 6'9"	2550mm 8'4"	3050mm 10'0"	3550mm 11'8"	4050mm 13'4"	4600mm 15'1"	5050mm 16'7"	5200mm 17'1"
1702mm 5' 7"	1088 1276	1161 1409	1269 1557	1362 1691	1548 1943	1718 2183	1874 2379	1909 2428
1981mm 6' 6"	1103 1299	1181 1441	1294 1597	1392 1740	1583 1999	1759 2249	1914 2443	1950 2494
2134mm 7' 0"	1112 1426	1191 1446	1308 1607	1401 1749	1593 2009	1764 2254	1923 2461	1960 2514
2286mm 7' 6"	1142 1465	1220 1504	1333 1671	1426 1808	1681 2053	1789 2318	2033 2523	2073 2577
2438mm 8' 0"	1166 1514	1245 1539	1416 1769	1450 1867	1695 2151	1906 2475	2050 2660	2087 2715
2590mm 8' 6"	1264 1651	1392 1769	1490 1882	1550 2058	1847 2377	1989 2641	2237 2789	2279 2847
2743mm 9'	1284 1759	1401 1779	1499 1891	1558 2063	1882 2426	2205 2646	2357 3125	2401 3190
3000mm 9' 10'	1284 1798	1411 1813	1504 1906	1568 2078	1891 2548	2254 2739	2449 3265	2495 3446

HALF Box		Over Guide Width						
Guide Height	2050mm 6'9"	2550mm 8'4"	3050mm 10'0"	3550mm 11'8"	4050mm 13'4"	4600mm 15'1"	5050mm 16'7"	5200mm 17'1"
1702mm 5' 7"	1189 1376	1272 1520	1390 1679	1493 1822	1695 2090	1874 2340	2040 2546	2080 2600
1981mm 6' 6"	1201 1397	1289 1548	1411 1715	1519 1867	1725 2141	1911 2401	2076 2605	2117 2661
2134mm 7' 0"	1210 1524	1299 1553	1426 1725	1529 1877	1735 2151	1916 2406	2085 2623	2127 2680
2286mm 7' 6"	1240 1563	1328 1612	1450 1789	1552 1936	1823 2195	1940 2470	2195 2685	2239 2744
2438mm 8' 0"	1264 1612	1352 1646	1534 1887	1578 1994	1838 2293	2058 2626	2212 2822	2254 2881
2590mm 8' 6"	1362 1749	1499 1877	1607 1999	1678 2185	1989 2519	2141 2793	2399 2951	2445 3014
2743mm 9'	1382 1857	1509 1887	1617 2009	1686 2190	2024 2568	2357 2798	2519 3287	2568 3357
3000mm 9' 10'	1382 1896	1519 1921	1651 2024	1695 2205	2034 2690	2406 2891	2612 3428	2663 3502

FULL Box		Over Guide Width						
Guide Height	2050mm 6'9"	2550mm 8'4"	3050mm 10'0"	3550mm 11'8"	4050mm 13'4"	4600mm 15'1"	5050mm 16'7"	5200mm 17'1"
1702mm 5' 7"	1249 1436	1328 1576	1455 1744	1573 1903	1781 2176	1980 2447	2153 2658	2196 2716
1981mm 6' 6"	1258 1454	1343 1602	1475 1779	1597 1945	1808 2225	2014 2504	2185 2714	2230 2773
2134mm 7' 0"	1268 1582	1352 1607	1490 1789	1607 1955	1818 2234	2019 2509	2195 2733	2239 2793
2286mm 7' 6"	1298 1621	1382 1666	1514 1852	1632 2014	1906 2279	2043 2573	2305 2795	2352 2857
2438mm 8' 0"	1322 1670	1406 1700	1597 1950	1656 2073	1921 2377	2161 2729	2322 2932	2367 2994
2590mm 8' 6"	1420 1807	1553 1931	1671 2063	1756 2264	2073 2602	2244 2896	2509 3061	2558 3126
2743mm 9'	1440 1915	1563 1940	1681 2073	1764 2269	2107 2651	2460 2901	2629 3396	2680 3469
3000mm 9' 10'	1440 1954	1573 1975	1715 2087	1774 2283	2117 2773	2509 2994	2723 3538	2777 3615

Above red line denotes 70mm Guides / 270mm end plates. Below red line denotes 90mm Guides / 300mm end plates  
 Below blue line denotes 90mm Guides / 360mm end plates  Denotes Paint Finish Pricing  Denotes Laminate Finish Pricing

Vision Slats								
Per Slat	47	59	70	82	93	106	116	208

Powder Coat								
Half Box	40	40	40	40	40	40	40	40
Full Box	60	60	60	60	60	60	60	60
Guides	40	40	40	40	40	40	40	40



**Options**

Lockable Override Covers to suit external fitted boxes	£46
External manual release	£152
Additional handset	£53
Electric photo cell	£60
Wireless key pad	£100
Wired key switch	£80
Battery backup	£269



**Colours**

Painted finishes (eggshell finish):



Lead Time\*\*  
1 week

Lead Time\*\*  
1 week

NEW Painted finishes (woodgrain eggshell).



Same price as standard painted finish.

Laminate finishes (woodgrain textured finish):



Lead Time\*\*  
2 weeks

\*\*Typical lead times for doors ordered by close of business on a Tuesday will delivered during the following week (1 week) or the second week following (2 weeks). Delivery day depends on location. These lead times are a guide only and can fluctuate during peak order periods, please seek confirmation.

**Ordering & Dimensions**

**ORDER BY OVERGUIDE WIDTH AND GUIDE HEIGHT** (on official order form). All Gliderol Roll-A-Glide doors are supplied with remote control operation with two handsets, a bottom rail safety edge, internal manual release and alarm buzzer as standard.

Doors over 9m<sup>2</sup> (see above price matrix) are supplied as standard with a safety break device.

All Roll A Glide doors are ordered using the guide height (GH) and the over guide width (OGW). The OGW is the opening width plus 180mm / 140mm (width of the guides = 2 x 90mm / 70mm).

**FITTING BETWEEN THE OPENING**

If fitting between the opening the over guide width of the door should be the narrowest measurement between the opening.

When calculating door prices use over guide width and guide height (if in between sizes use the price of the next door size up).

Motors may be fitted to the left or right. Please state which side when ordering (as viewed from the inside looking out (VILO)).

Width Measurement Guide

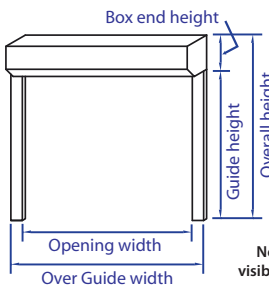

Height Measurement Guide

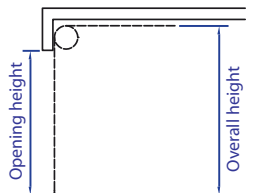

Note: A portion of the bottom rail will be visible below the top rail of the opening when the door is in the open position.

Box End Details

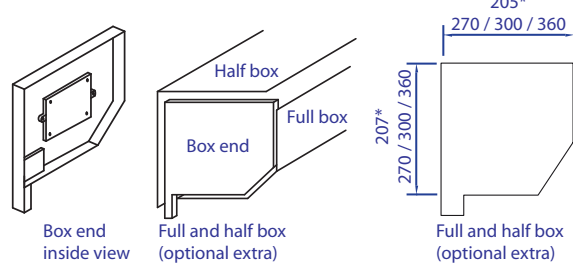

\*Refers to the Roll-a-Glide Compact only

Guide Specification

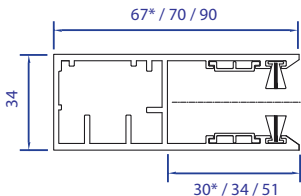

Notes on colour: Door guides are available in colours matching the door curtain except laminate door colours (supplied in brown). Coloured guide rails are supplied as standard, however they may not match the lath colour. The manufacturing process for the lath profile results in a textured finish, whilst all other coloured items (guides, bottom laths, lock laths, optional fascias and vision panels) are supplied in a satin finish so cannot be guaranteed to match exactly. Over time, some scuffing may occur on front and rear surfaces of doors as a result of their normal operation.

Note: Full and half boxes are available to match painted coloured door curtains. Vandyke Brown boxes are supplied as standard for painted wood effect and laminated door curtains.

Fixing Options

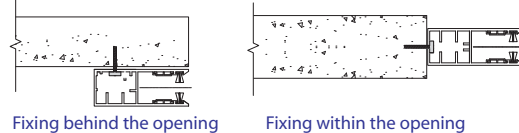

**IMPORTANT NOTES**

- Doors with 70mm or 90mm guides are available with boxes. Doors with Half/Full boxes have 300/360mm aluminium/steel end plates.
- Doors with 270 & 300mm endplates have cylindrical barrels and spring loaded locking straps. Doors with 360mm endplates have a continuous carrier strip that attaches the door curtain to a 102mm hexagonal barrel.
- Powder Coating of box includes end plates.
- All powder coating prices are NET, not subject to discount.
- Actual RAL colours and finish may vary slightly from the door curtain colours.
- Guides/head plates/box/vision slats are available to colour match the door colour (except laminated finishes, which are supplied in Vandyke Brown). The inside face of all laminate doors is Vandyke Brown.
- Please note that guides/head plates and bottom lath may vary in colour to the door curtain.
- Some bottom rail will be visible below the top of the opening when door is in the open position.

**Delivery**

Price Includes delivery to Distributor premises on mainland UK. Delivery to site £40 per door.

Half Box	Over Guide Width					
Guide Height	2050mm 6'9"	2134mm 7'0"	2254mm 7'5"	2410mm 7'11"	2560mm 8'5"	3000mm 9'10"
1981mm 6' 6"	1118 1358	1149 1396	1159 1409	1188 1445	1217 1481	1250 1524
2134mm 7' 0"	1148 1394	1189 1444	1214 1475	1273 1547	1293 1572	1346 1639
2286mm 7' 6"	1178 1430	1224 1486	1264 1535	1318 1601	1357 1649	1390 1692

Full Box	Over Guide Width					
Guide Height	2050mm 6'9"	2134mm 7'0"	2254mm 7'5"	2410mm 7'11"	2560mm 8'5"	3000mm 9'10"
1981mm 6' 6"	1200 1440	1235 1482	1250 1500	1285 1542	1320 1584	1370 1644
2134mm 7' 0"	1230 1476	1275 1530	1305 1566	1370 1644	1396 1675	1466 1759
2286mm 7' 6"	1260 1512	1310 1572	1355 1626	1415 1698	1460 1752	1510 1812

Denotes Paint Finish Pricing     Denotes Laminate Finish Pricing

**Powder Coat**

Full Box	60	60	60	60	60	60
Half Box	40	40	40	40	40	40
Guides	40	40	40	40	40	40

**Options**

Lockable Override Covers to suit external fitted boxes    £46

**OPTIONAL EXTRAS**

External manual release    £152

Additional handset    £53

Electric photo cell    £60

Battery backup    £269

Wireless key pad    £100

Anti vandal key pad    £215

Wired key switch    £80

**Colours**

Painted finishes (eggshell finish):



Lead Time\*\*  
1 week

Laminate finishes (woodgrain textured finish):



Lead Time\*\*  
2 weeks

\*\*Typical lead times for doors ordered by close of business on a Tuesday will be delivered during the following week (1 week) or the second week following (2 weeks). Delivery day depends on location. These lead times are a guide only and can fluctuate during peak order periods, please seek confirmation.

**Ordering**

**PLEASE ORDER BY OVERGUIDE WIDTH AND GUIDE HEIGHT (on official order form).** All Gliderol Roll-A-Glide doors are supplied with remote control operation with 2 handsets, a bottom rail safety edge, internal manual release and alarm buzzer as standard.

All Roll A Glide doors are ordered using the guide height (GH) and the over guide width (OGW). The OGW is the opening width plus 136mm (width of the guides = 2 x 68mm).

For technical specifications please see page 7.

**IMPORTANT NOTES**

- Doors are supplied with full box as standard and are supplied with 205mm aluminium head plates.
- Boxes/Guides/head plates are available to colour match the door colour (except laminated finishes, which are supplied in Vandyke Brown). The inside face of all laminate doors is Vandyke Brown.
- Powder Coating of box includes end plates.
- All powder coating prices are NET, not subject to discount.
- Actual RAL colours and finish may vary slightly from the door curtain colours.
- Please note that guides/head plates and bottom lath may vary in colour to the door curtain.
- Some bottom rail will be visible below the top of the opening when door is in the open position.

**Delivery**

Price Includes delivery to Distributor premises on mainland UK. Delivery to site £40 per door.

**FITTING BETWEEN THE OPENING**

If fitting between the opening the over guide width of the door should be the narrowest measurement between the opening.

When calculating door prices use over guide width and guide height (if in between sizes use the price of the next door size up). Motors may be fitted to the left or right. Please state which side when ordering (as viewed from the inside looking out (VILO)).





Half Box	Over Guide Width				
Guide Height	1500mm 4'11"	2050mm 6'9"	2550mm 8'4"	3050mm 10'0"	3550mm 11'8"
1981mm 6' 6"	805	885	910	980	1060
	966	1062	1092	1176	1272
2134mm 7' 0"	855	915	970	1020	1140
	1026	1098	1164	1224	1368
2286mm 7' 6"	900	985	1030	1190	1250
	1080	1182	1236	1428	1500
2438mm 8'0"	980	1075	1120	1225	1310
	1176	1290	1344	1470	1572

Full Box	Over Guide Width				
Guide Height	1500mm 4'11"	2050mm 6'9"	2550mm 8'4"	3050mm 10'0"	3550mm 11'8"
1981mm 6' 6"	927	1052	1117	1228	1348
	1088	1229	1299	1424	1560
2134mm 7' 0"	977	1082	1177	1268	1428
	1148	1265	1371	1472	1656
2286mm 7' 6"	1022	1152	1237	1438	1538
	1202	1349	1443	1676	1788
2438mm 8'0"	1102	1242	1327	1473	1598
	1298	1457	1551	1718	1860

Denotes Paint Finish Pricing     Denotes Laminate Finish Pricing

**Powder Coat**

Full Box	60	60	60	60	60	60
Half Box	40	40	40	40	40	40
Guides	40	40	40	40	40	40

**Colours**

Painted finishes (eggshell finish):

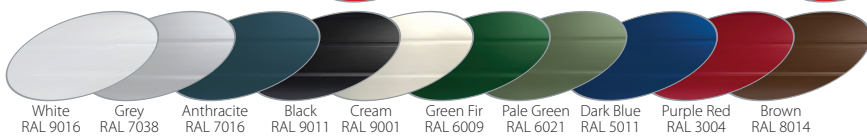

Lead Time\*\*  
1 week

Lead Time\*\*  
1 week

NEW Painted finishes (woodgrain eggshell).



Same price as standard painted finish.

Laminate finishes (woodgrain textured finish):



Lead Time\*\*  
2 weeks

**\*\*Typical lead times for doors ordered by close of business on a Tuesday will be delivered during the following week (1 week) or the second week following (2 weeks). Delivery day depends on location. These lead times are a guide only and can fluctuate during peak order periods, please seek confirmation.**

**A Note Concerning Colours:** Door guides are available in colours matching the door curtain except laminate door colours (supplied in brown). Coloured guide rails are supplied as standard, however they may not match the lath colour. The manufacturing process for the lath profile results in a textured finish, whilst all other coloured items (guides, bottom laths, lock laths, optional fascias and vision panels) are supplied in a satin finish so cannot be guaranteed to match exactly. Over time, some scuffing may occur on front and rear surfaces of doors as a result of their normal operation.

**Ordering**

ORDER BY OVERGUIDE WIDTH AND GUIDE HEIGHT (on official order form).

All Roll A Glide doors are ordered using the **guide height (GH)** and the **over guide width (OGW)**. The OGW is the opening width plus 140mm (width of the guides = 2 x 70mm).

For technical specifications please see page 7.

**FITTING BETWEEN THE OPENING** If fitting between the opening the over guide width of the door should be the narrowest measurement between the opening. When calculating door prices use over guide width and guide height (if in between sizes use the price of the next door size up).

**IMPORTANT NOTES**

- Doors are supplied with half box as standard and are supplied with 300mm aluminium head plates.
- Guides/head plates are available to colour match the door colour (except laminated finishes, which are supplied in Vandyke Brown). The inside face of all laminate doors is Vandyke Brown.
- Powder Coating of box includes end plates.
- All powder coating prices are NET, not subject to discount.
- Actual RAL colours and finish may vary slightly from the door curtain colours.
- Please note that guides/head plates and bottom lath may vary in colour to the door curtain.
- Some bottom rail will be visible below the top of the opening when door is in the open position.



**Delivery**

Price Includes delivery to Distributor premises on mainland UK. Delivery to site £40 per door.

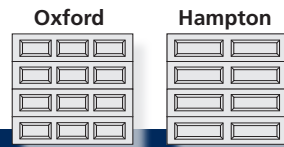

Lead Time\*\*  
**1 week**

Sizes	Standard Opening Width - White and Woodgrain															
Opening Height mm	2080mm 6' 10"	2134mm 7'	2286mm 7' 6"	2438mm 8'	2591mm 8' 6"	2743mm 9'	2895mm 9' 6"	3048mm 10'	3353mm 11'	3658mm 12'	3962mm 13'	4267mm 14'	4420mm 14' 6"	4572mm 15'	4724mm 15' 6"	4877mm 16'
1800, 1820, 1840, 1860 1880, 1900, 1920 1940 2040, 2060, 2080, 2100 2120, 2140, 2160, 2180	665	667	711	745	776	875	884	1005	1255	1388	1417	1554	1587	1594	1641	1711
	915	924	979	1014	1037	1106	1131	1180	1455	1587	1616	1753	1788	1794	1841	1910
2250, 2270, 2290, 2310, 2330, 2350, 2370, 2390, 2410, 2430, 2450, 2470, 2490	837	855	741	769	961	1031	1056	1106	1355	1487	1517	1654	1687	1694	1741	1810
	1003	1012	1067	1126	1124	1192	1218	1268	1542	1675	1704	1841	1873	1881	1928	1999
2510, 2530, 2550, 2570, 2590, 2610, 2630, 2650 2670, 2690, 2710, 2725	916	936	858	894	1054	1129	1156	1211	1484	1629	1661	1812	1848	1855	1907	1982
	1140	1150	1209	1234	1273	1348	1375	1430	1730	1874	1907	2058	2093	2101	2154	2230
2745, 2760, 2780, 2800, 2820, 2840, 2860 2880, 2900, 2920, 2940, 2960, 2980	985	985	1135	1053	1067	1148	1198	1450	1529	1627	1669	1744	1792	1833	1915	1978
	1169	1169	1206	1244	1258	1340	1395	1635	1750	1846	1888	1962	2011	2052	2134	2202

Sizes	Standard Opening Width - Coloured															
Opening Height mm	2080mm 6' 10"	2134mm 7'	2286mm 7' 6"	2438mm 8'	2591mm 8' 6"	2743mm 9'	2895mm 9' 6"	3048mm 10'	3353mm 11'	3658mm 12'	3962mm 13'	4267mm 14'	4420mm 14' 6"	4572mm 15'	4724mm 15' 6"	4877mm 16'
1800, 1820, 1840, 1860 1880, 1900, 1920 1940 2040, 2060, 2080, 2100 2120, 2140, 2160, 2180	699	701	747	783	815	919	929	1056	1318	1458	1488	1632	1667	1674	1724	1797
2250, 2270, 2290, 2310, 2330, 2350, 2370, 2390, 2410, 2430, 2450, 2470, 2490	879	898	779	808	1010	1083	1109	1162	1423	1562	1593	1737	1772	1779	1829	1901
2510, 2530, 2550, 2570, 2590, 2610, 2630, 2650 2670, 2690, 2710, 2725	962	983	901	939	1107	1186	1214	1272	1559	1711	1745	1903	1941	1948	2003	2082
2745, 2760, 2780, 2800, 2820, 2840, 2860 2880, 2900, 2920, 2940, 2960, 2980	1035	1035	1192	1106	1121	1206	1258	1523	1606	1709	1753	1832	1882	1925	2011	2077

Features	Standard Size Range Embossments/Windows															
Hampton	2	2	2	2	0	0	0	3	3	3	0	4	4	4	4	4
Oxford	3	3	3	4	4	4	4	5	5	6	6	7	7	7	7	8

- Denotes White Door Pricing
- Denotes Golden Oak and Rosewood Pricing
- Denotes Coloured Door Pricing
- Above red line supplied with Extension Springs. Below red line supplied with Rear Mount Torsion Springs
- Below blue line supplied with Front Mount Torsion Springs
- Denotes not available in Hampton design

Finish	Door Style			
	Oxford		Hampton	
Colour	Smooth Finish	Woodgrain Finish	Smooth Finish	Woodgrain Finish
White	•	•	•	•
Black	•	•	•	•
Anthracite	•	•	•	•
Racing Green	•	•	•	•
Vandyke Brown	•	•	•	•
Golden oak	•	•	•	•
Rosewood	•	•	•	•

Lead Time\*\*  
**1 week**      Lead Time\*\*  
**2 weeks**

\*\*Typical lead times for doors ordered by close of business on a Tuesday will delivered during the following week (1 week) or the second week following (2 weeks). Delivery day depends on location. These lead times are a guide only and can fluctuate during peak order periods, please seek confirmation.

Wider doors available upon application. Available in woodgrain and smooth finish (please see table below).

Please note that in low head room situations clear opening heights may be less than specified on order.

**Colours**

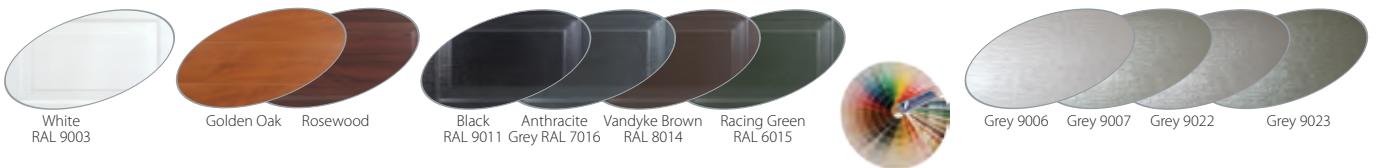

**Options**

See page 14

Can't see your colour? Pick any RAL colour!\*

\* RAL colours may vary slightly from exact shade

**Delivery**

Price Includes delivery to Distributor premises on mainland UK. Delivery to site £40 per door.



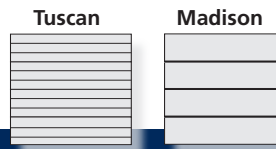

Lead Time\*\*  
**1 week**

Sizes	Standard Opening Width - White and Woodgrain															
Opening Height mm	2080mm 6' 10"	2134mm 7'	2286mm 7' 6"	2438mm 8'	2591mm 8' 6"	2743mm 9'	2895mm 9' 6"	3048mm 10'	3353mm 11'	3658mm 12'	3962mm 13'	4267mm 14'	4420mm 14' 6"	4572mm 15'	4724mm 15' 6"	4877mm 16'
1800, 1820, 1840, 1860 1880, 1900, 1920 1940 2040, 2060, 2080, 2100 2120, 2140, 2160, 2180	581	595	640	667	690	746	761	804	1062	1177	1200	1314	1346	1350	1390	1448
	698	714	768	801	828	896	914	965*	1275*	1413*	1440*	1577*	1616*	1620*	1668*	1738*
2250, 2270, 2290, 2310, 2330, 2350, 2370, 2390, 2410, 2430, 2450, 2470, 2490	837	855	674	704	961	1031	1056	1106	1355	1487	1517	1654	1687	1694	1741	1810
	1005	1026	809	845	1154	1238	1268	1328*	1626*	1785*	1821*	1985*	2025*	2033*	2090*	2172*
2510, 2530, 2550, 2570, 2590, 2610, 2630, 2650 2670, 2690, 2710, 2725	916	936	674	704	1054	1129	1156	1211	1484	1629	1661	1812	1848	1855	1907	1982
	1100	1124	809	845	1265	1355	1388	1454*	1781*	1955*	1994*	2175*	2218*	2226*	2289*	2379*
2745, 2760, 2780, 2800, 2820, 2840, 2860 2880, 2900, 2920, 2940, 2960, 2980	985	985	674	704	1067	1148	1198	1450	1529	1627	1669	1744	1792	1833	1915	1978
	1182	1182	809	845	1281	1378	1438	1740*	1835*	1953*	2003*	2093*	2151*	2200*	2298*	2374*

\*Tuscan only

Sizes	Standard Opening Width - Coloured															
Opening Height mm	2080mm 6' 10"	2134mm 7'	2286mm 7' 6"	2438mm 8'	2591mm 8' 6"	2743mm 9'	2895mm 9' 6"	3048mm 10'	3353mm 11'	3658mm 12'	3962mm 13'	4267mm 14'	4420mm 14' 6"	4572mm 15'	4724mm 15' 6"	4877mm 16'
1800, 1820, 1840, 1860 1880, 1900, 1920 1940 2040, 2060, 2080, 2100 2120, 2140, 2160, 2180	611	625	672	701	725	784	800	845	1116	1236	1260	1380	1414	1418	1460	1521
2250, 2270, 2290, 2310, 2330, 2350, 2370, 2390, 2410, 2430, 2450, 2470, 2490	879	898	708	740	1010	1083	1109	1162	1423	1562	1593	1737	1772	1779	1829	1901
2510, 2530, 2550, 2570, 2590, 2610, 2630, 2650 2670, 2690, 2710, 2725	962	983	708	740	1107	1186	1214	1272	1559	1711	1745	1903	1941	1948	2003	2082
2745, 2760, 2780, 2800, 2820, 2840, 2860 2880, 2900, 2920, 2940, 2960, 2980	1035	1035	708	740	1121	1206	1258	1523	1606	1709	1753	1832	1882	1925	2011	2077

Features	Standard Size Range Embossments/Windows															
Tuscan/Madison	3	3	3	4	4	4	4	5	5	6	6	7	7	7	7	8

- Denotes White Door Pricing     Denotes Golden Oak and Rosewood Pricing     Denotes Coloured Door Pricing
- Above red line supplied with Extension Springs. Below red line supplied with Rear Mount Torsion Springs
- Below blue line supplied with Front Mount Torsion Springs

Finish	Door Style			
	Tuscan		Madison	
Colour	Smooth Finish	Woodgrain Finish	Smooth Finish	Woodgrain Finish
White	•	•		•
Black	•	•		•
Anthracite	•	•		•
Racing Green	•	•		•
Vandyke Brown	•	•		•
Golden oak	•		• ***	
Rosewood	•		• ***	

\*\*\* Panel deflections may be visible. Max width 2895mm

Lead Time\*\*  
**1 week**    **2 weeks**

\*\*Typical lead times for doors ordered by close of business on a Tuesday will delivered during the following week (1 week) or the second week following (2 weeks). Delivery day depends on location. These lead times are a guide only and can fluctuate during peak order periods, please seek confirmation.

Wider doors available upon application. Available in woodgrain and smooth finish (please see table below).

Please note that in low head room situations clear opening heights may be less than specified on order.

**Colours**

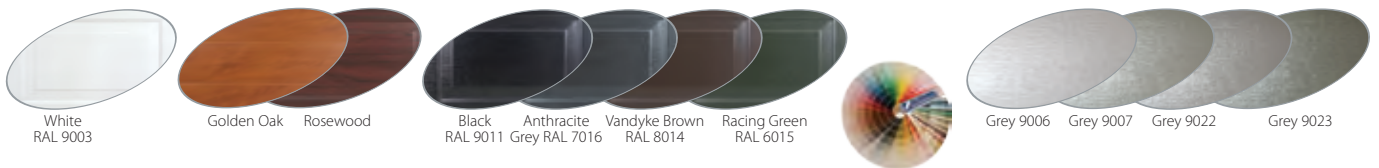

**Options** See page 14

Can't see your colour? Pick any RAL colour!\*

\* RAL colours may vary slightly from exact shade

**Delivery**

Price Includes delivery to Distributor premises on mainland UK. Delivery to site £40 per door.



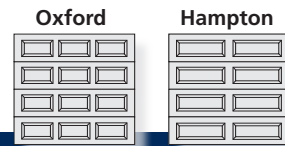

Lead Time\*\*  
**1 week**

Sizes	Standard Opening Width - White and Woodgrain															
Opening Height mm	2080mm 6' 10"	2134mm 7'	2286mm 7' 6"	2438mm 8'	2591mm 8' 6"	2743mm 9'	2895mm 9' 6"	3048mm 10'	3353mm 11'	3658mm 12'	3962mm 13'	4267mm 14'	4420mm 14' 6"	4572mm 15'	4724mm 15' 6"	4877mm 16'
1800, 1980, 2030, 2080, 2130, 2180	1013	1013	1082	1116	1132	1205	1256	1487	1570	1663	1698	1774	1820	1857	1937	1995
	1180	1180	1263	1300	1313	1387	1438	1669	1777	1871	1907	1982	2028	2064	2146	2204
2245, 2290, 2470, 2520	1099	1099	1186	1209	1221	1300	1351	1585	1663	1754	1793	1865	1910	1948	2026	2087
	1268	1268	1351	1391	1299	1482	1533	1761	1868	1963	2001	2073	2118	2157	2234	2300
2570, 2620, 2670, 2720	1224	1224	1272	1293	1307	1288	1441	1690	1770	1868	1909	1983	2032	2072	2155	2218
	1409	1409	1444	1484	1498	1581	1635	1874	1989	2087	2127	2203	2251	2291	2374	2442
2870, 2960	1245	1245	1296	1313	1327	1409	1459	1711	1790	1888	1929	2004	2053	2093	2176	2239
	1430	1430	1466	1505	1519	1601	1656	1895	2011	2107	2148	2223	2272	2312	2395	2463

Sizes	Standard Opening Width - Coloured															
Opening Height mm	2080mm 6' 10"	2134mm 7'	2286mm 7' 6"	2438mm 8'	2591mm 8' 6"	2743mm 9'	2895mm 9' 6"	3048mm 10'	3353mm 11'	3658mm 12'	3962mm 13'	4267mm 14'	4420mm 14' 6"	4572mm 15'	4724mm 15' 6"	4877mm 16'
1800, 1980, 2030, 2080, 2130, 2180	1097	1097	1126	1161	1178	1254	1307	1547	1633	1730	1766	1845	1893	1932	2015	2075
	1189	1189	1314	1352	1366	1443	1496	1736	1849	1946	1984	2062	2110	2147	2232	2293
2245, 2290, 2470, 2520	1324	1324	1234	1258	1270	1352	1406	1649	1730	1825	1865	1940	1987	2026	2108	2171
	1347	1347	1406	1447	1351	1542	1595	1832	1943	2042	2082	2156	2203	2244	2324	2392

Features	Standard Size Range Embossments/Windows															
Hampton	2	2	2	2	0	0	0	3	3	3	0	4	4	4	4	4
Oxford	3	3	3	4	4	4	4	5	5	6	6	7	7	7	7	8

Denotes White Door Pricing     Denotes Golden Oak and Rosewood Pricing     Denotes Coloured Door Pricing

Above red line supplied with Extension Springs. Below red line supplied with Rear Mount Torsion Springs

Below blue line supplied with Front Mount Torsion Springs    [ - ] Denotes not available in Hampton design

Finish	Door Style			
	Oxford		Hampton	
Colour	Smooth Finish	Woodgrain Finish	Smooth Finish	Woodgrain Finish
White	•	•	•	•
Black	•	•	•	•
Anthracite	•	•	•	•
Racing Green	•	•	•	•
Vandyke Brown	•	•	•	•
Golden oak	•	•	•	•
Rosewood	•	•	•	•

Lead Time\*\*  
**1 week**    Lead Time\*\*  
**2 weeks**

\*\*Typical lead times for doors ordered by close of business on a Tuesday will be delivered during the following week (1 week) or the second week following (2 weeks). Delivery day depends on location. These lead times are a guide only and can fluctuate during peak order periods, please seek confirmation.

Wider doors available upon application. Available in woodgrain and smooth finish (please see table below).

Please note that in low head room situations clear opening heights may be less than specified on order.

**Colours**

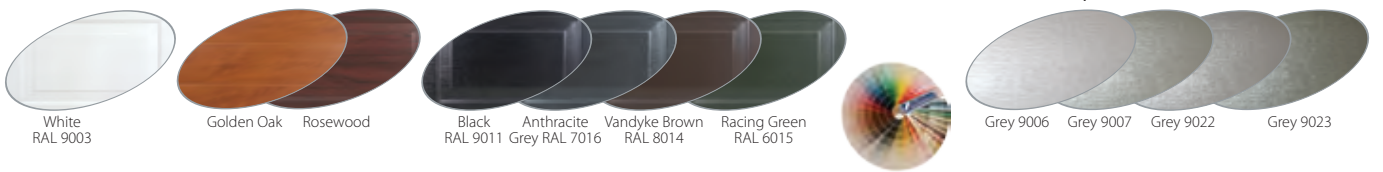

**Options**    See page 14

Can't see your colour? Pick any RAL colour\*

\* RAL colours may vary slightly from exact shade

**Delivery**

Price Includes delivery to Distributor premises on mainland UK. Delivery to site £40 per door.



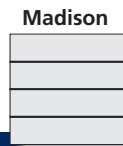
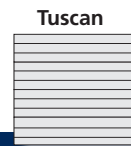

Lead Time\*\*  
**1 week**

Sizes	Standard Opening Width - White and Woodgrain															
Opening Height mm	2080mm 6' 10"	2134mm 7'	2286mm 7' 6"	2438mm 8'	2591mm 8' 6"	2743mm 9'	2895mm 9' 6"	3048mm 10'	3353mm 11'	3658mm 12'	3962mm 13'	4267mm 14'	4420mm 14' 6"	4572mm 15'	4724mm 15' 6"	4877mm 16'
1800, 1980, 2030, 2080, 2130, 2180	924	924	926	983	985	1077	1138	1138	1361	1539	1584	1386	1512	1626	1655	1683
	1077	1077	1117	1119	1122	1253	1318	1318	1560	1771	1887	1875	1987	2036	2090	2123
2245, 2290, 2470, 2520	1099	1099	1140	1162	1174	1250	1299	1524	1599	1686	1724	1793	1836	1873	1948	2006
	1268	1268	1299	1337	1249	1425	1474	1693	1796	1887	1924	1993	2036	2074	2148	2211
2570, 2620, 2670, 2720	1224	1224	1006	1077	1307	1288	1441	1690	1770	1868	1909	1983	2032	2072	2155	2218
	1409	1409	1444	1484	1498	1581	1635	1874	1989	2087	2127	2203	2251	2291	2374	2442
2870, 2960	1245	1245	1296	1313	1327	1409	1459	1711	1790	1888	1929	2004	2053	2093	2176	2239
	1430	1430	1466	1505	1519	1601	1656	1895	2011	2107	2148	2223	2272	2312	2395	2463

4 Panel  
5 Panel  
6 Panel

Sizes	Standard Opening Width - Coloured															
Opening Height mm	2080mm 6' 10"	2134mm 7'	2286mm 7' 6"	2438mm 8'	2591mm 8' 6"	2743mm 9'	2895mm 9' 6"	3048mm 10'	3353mm 11'	3658mm 12'	3962mm 13'	4267mm 14'	4420mm 14' 6"	4572mm 15'	4724mm 15' 6"	4877mm 16'
1800, 1980, 2030, 2080, 2130, 2180	961	961	964	1023	1025	1121	1184	1184	1416	1601	1648	1442	1573	1692	1722	1751
	1143	1143	1186	1209	1221	1300	1351	1585	1663	1754	1793	1865	1910	1948	2026	2087
2245, 2290, 2470, 2520	1273	1273	1047	1121	1360	1340	1499	1758	1841	1943	1986	2063	2114	2155	2242	2307
	1295	1295	1348	1366	1381	1466	1518	1780	1862	1964	2007	2085	2136	2177	2264	2329

4 Panel  
5 Panel  
6 Panel

Features	Standard Size Range Embossments/Windows															
Tuscan/Madison	3	3	3	4	4	4	4	5	5	6	6	7	7	7	7	8

Denotes White Door Pricing    Denotes Golden Oak and Rosewood Pricing    Denotes Coloured Door Pricing

Above red line supplied with Extension Springs. Below red line supplied with Rear Mount Torsion Springs

Below blue line supplied with Front Mount Torsion Springs

Finish	Door Style			
	Tuscan		Madison	
Colour	Smooth Finish	Woodgrain Finish	Smooth Finish	Woodgrain Finish
White	•	•		•
Black	•	•		•
Anthracite	•	•		•
Racing Green	•	•		•
Vandyke Brown	•	•		•
Golden oak	•			
Rosewood	•			

Lead Time\*\*  
**1 week**   Lead Time\*\*  
**2 weeks**

\*\*Typical lead times for doors ordered by close of business on a Tuesday will delivered during the following week (1 week) or the second week following (2 weeks). Delivery day depends on location. These lead times are a guide only and can fluctuate during peak order periods, please seek confirmation.

Wider doors available upon application. Available in woodgrain and smooth finish (please see table below).

Please note that in low head room situations clear opening heights may be less than specified on order.

**Colours**

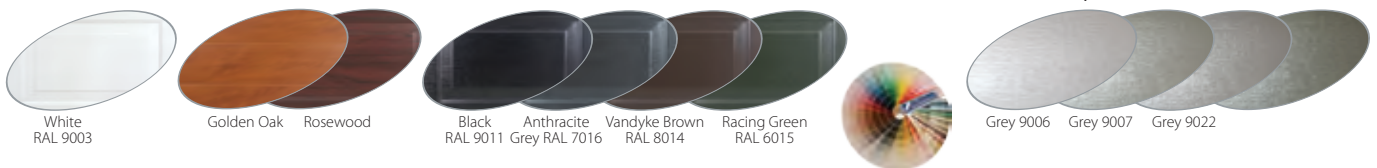

Can't see your colour? Pick any RAL colour!\*

\* RAL colours may vary slightly from exact shade

**Options** See page 14

**Delivery**

Price Includes delivery to Distributor premises on mainland UK. Delivery to site £40 per door.



**Options**

**WINDOW OPTIONS**

Oxford, Tuscan, Madison, Clear/Stippled

Hampton

NEW Round and square windows (stainless steel)

£87 per window

£101 per window

£132 per window



Traditional



Traditional (Hampton)



County



County (Hampton)



Stainless steel glazing units.



Sunburst



Sunburst (Hampton)



Canterbury



Canterbury (Hampton)



Horizon



Horizon (Hampton)



Waterton



Waterton (Hampton)



Cascade



Cascade (Hampton)



**AUTOMATION**

Glidermatic GTS 2000 remote auto operator chain drive (700N)

£395

Glidermatic GTS Optima remote auto operator belt drive (1000N)

£445

Manual release

£35

Wireless digital entry key pad (wall mounted)

£100

**OPTIONAL EXTRAS**

T-bar handle lockset

£26

Round handle set - cast aluminium in the following finishes:

- Brushed Aluminium
- Antique Bronze
- Chrome finish
- Gold finish
- Black

£99

£99

£99

£99

£99

If fixing to side walls extension brackets can be supplied as "C" section up to 1350mm long

£12 per length

Punched right angle

£24 per 3 metre lengths

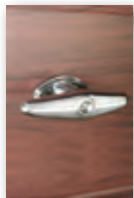

T-bar Chrome effect



Antique Bronze



Chrome



Brushed Aluminium



Black



Gold

**Colour Matched Frames**

COLOUR MATCHED FRAMES (can be supplied in Racing Green, Black or Vandyke Brown (white supplied as standard))

- Doors from 6'10" 2080mm wide up to and including 10' 3048mm wide up to and including 2490mm high £140
- Doors from 10' 3048mm wide up to and including 16' 4877mm wide up to and including 2490mm high £205
- Doors from 6'10" 2080mm wide up to and including 10' 3048mm wide from 2491mm high up to and including 3020mm high £190
- Doors from 10' 3048mm wide up to and including 16' 4877mm wide from 2491mm high up to and including 3020mm high £255

**Between Reveal & Fascias**

**OPTIONS FOR DOORS FITTED BETWEEN THE REVEAL**

Between the reveal fitting kit (Stock colours including laminates) £195

Gap to ceiling fascia kit (Stock colours including laminates) £85

Renovation kit (Stock colours including laminates) £135

Door frame fascia kit (Stock colours including laminates) £135

**Colours: RAL and Special Order**

Safe•T•Glide Matt finish - all RAL / BS colours. Complete doors. Front face only (per m<sup>2</sup>) £30 net (not subject to discount)

Safe•T•Glide metallic paint finishes - RAL 9022, 9023, 9006 & 9007 Complete doors. Front face only (per m<sup>2</sup>) £30 net (not subject to discount)

Insul•Glide Matt finish - all RAL / BS colours. Complete doors. Front face only (per m<sup>2</sup>) £42 net (not subject to discount)

Insul•Glide metallic paint finishes - RAL 9022, 9023, 9006 & 9007 Complete doors. Front face only (per m<sup>2</sup>) £42 net (not subject to discount)

Individual Door panels Front face only (per m<sup>2</sup>) £60 net

Door frames (per linear metre) £25 net

**Delivery**

Price Includes delivery to Distributor premises on mainland UK. Delivery to site £40 per door.

For technical specifications please see page 15.

U value (EN13241)	1.4-1.6 W/m²K
Water Penetration (EN12425)	Class 3, 150Pa
Resistance to wind load (EN12424)	Class 5, 1100Pa
Air Permeability (EN12426)	Class 3

**Minimum clearances manual/automatic doors:**

**Extension Spring:**

- Sideroom 90mm
- Headroom 110/150mm
- With t-bar handle lockset (motor offset)
- Sideroom 90mm
- Headroom 155mm
- With round handle lockset (motor offset)
- Sideroom 90mm
- Headroom 170mm

**Minimum clearances manual/automatic doors:**

**Rear Mount Torsion:**

- Sideroom 90mm
- Headroom 110/150mm
- With t-bar handle lockset (motor offset)
- Sideroom 90mm
- Headroom 155mm
- With round handle lockset (motor offset)
- Sideroom 90mm
- Headroom 170mm

**Minimum clearances manual/automatic doors:**

**Front Mount Torsion:**

- Sideroom 90mm
- Headroom 230/270mm
- With t-bar handle lockset
- Sideroom 90mm
- Headroom 230/270mm
- With round handle lockset
- Sideroom 90mm
- Headroom 230/270mm

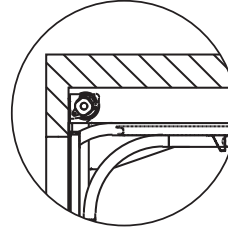

Detail: Front mount spring

**Structural Depth**  
Doors up to 2150 high = 2250+660mm  
Doors from 2150-2400 = 2500+660mm  
Doors from 2400-2900 = 3000+660mm

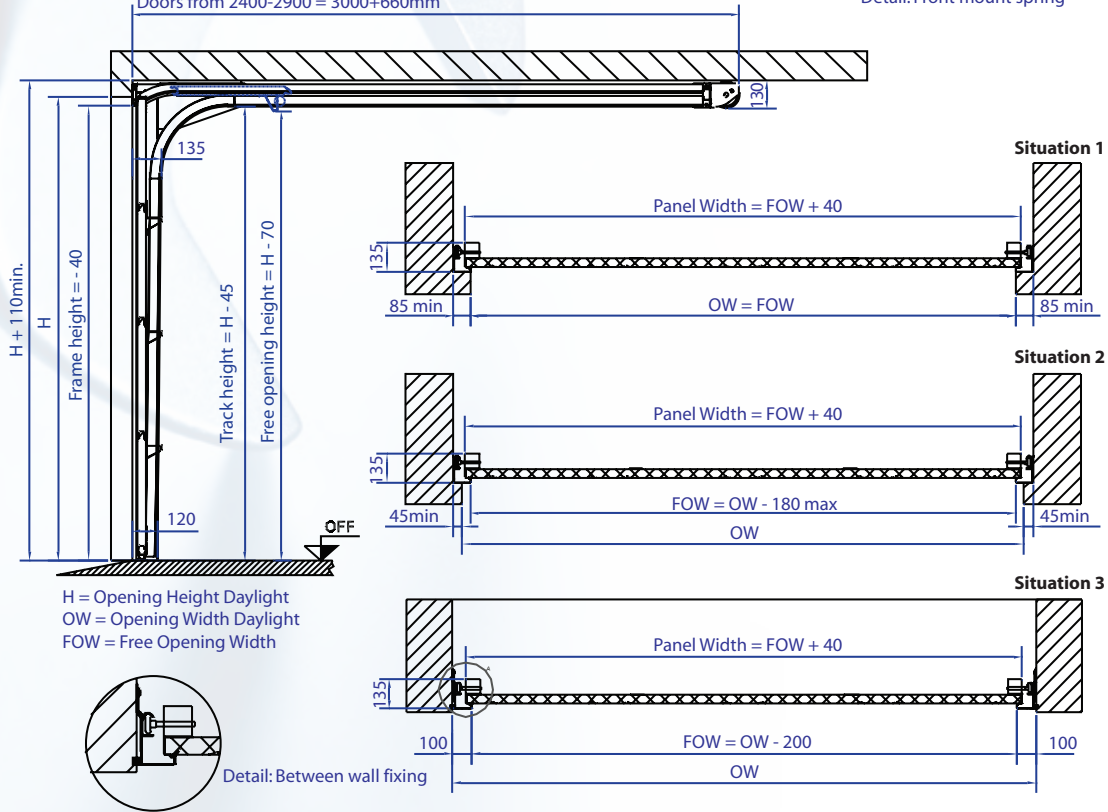

H = Opening Height Daylight  
OW = Opening Width Daylight  
FOW = Free Opening Width

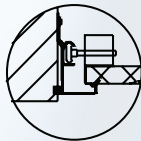

Detail: Between wall fixing

**Fascias and fixing accessories**

<p><b>Between Reveal Fitting Kit</b> Kit includes fascias for frame legs, frame head and side wall fixing brackets</p> <p>Detail 'A' Fascia for side section Fascia for side section (see detail 'A')</p>	<p><b>Gap to Ceiling Fascia Kit</b> Kit includes frame header fascia and infill section</p> <p>Ceiling Infill section to fill gap above door Door top header piece part of standard frame</p>	<p><b>Renovation Kit</b> To cover unsightly brickwork around the garage opening. Kit includes fascias for frame legs, frame head and fitting brackets</p>	<p><b>Door Frame Fascias</b> To clad exposed door frame. Kit includes fascias for frame legs, frame head and fitting brackets</p> <p>Frame leg section Side Fascia for header Section</p>
---	---	---	---



**GLIDEROL  
GARAGE DOORS**

Opening Doors Around the World®  
www.gliderol.co.uk

# Schedule of Manufacturer's Warranty Period

**Gliderol Roller Doors** - GlideRol A Door A & AA - Mini Roller Door - B Series Door - Roll A Glide - Roll A Glide Compact - Roll A Glide Manual 77

**Gliderol Sectional Doors** - Insul Glide - Safe T Glide

**Gliderol Automation** - Glidermatic RW1 Rol A Matic - IGDU Industrial - Glide A Tube - Glidermatic GTS 2000 - Glidermatic Optima

- Domestic/Residential use - 10 years corrosion free on door panel excludes paint surface rubbing or fading. (GlideRol A Door Mini Roller door has 3 year total warranty cover).
- 1 year on the lock and face plate, spring, bottom roller, weatherseal and polyglide, if fitted by an authorised Gliderol Distributor or Gliderol Technician. 3 month warranty on spring tension.
- Industrial/Commercial use - 1 year on the lock and face plate, spring, bottom roller, weatherseal and polyglide, if fitted by an authorised Gliderol Distributor or Gliderol Technician. 3 month warranty on spring tension.

*The manufacturer strongly recommends that all Gliderol products be serviced by an authorised Gliderol Distributor or Gliderol Technician every 12 months to ensure longevity of the products' life. Failure to do this may result in any warranty being invalid.*

Warranties of 1 year transmitter handsets (transmitters must be kept in normal conditions of humidity and temperature), 2 years electrical, 5 years tubular motors, 6 years mechanical and 10 years paint finish apply to all Gliderol doors (except Mini Roller Doors see above).

Garage doors should be inspected upon installation and viewed in natural daylight (not direct sunlight) from a standard distance of 3 metres to view their overall appearance. From this distance the door panel should appear free from visible marks or distortion, stains, blemishes, indentations or scuffs.

Only marks visible from a distance of more than 3 metres will be considered under warranty.

## PRODUCT WARRANTY CONDITIONS

### Warranty Conditions

1. Subject to the under mentioned specific limitations and exceptions, the Manufacturer warrants all new doors, motors and electronic components of its manufacture to be free from defect in workmanship under normal use and service and further warrants all installation carried out by the Manufacturer or by its nominated installers to be free from defects and workmanship its obligations hereunder being limited to making good any such defect PROVIDED THAT notice of any claimed defect in material workmanship in or resulting from installation of any door shall have been given to the Manufacturer within the period from date of installation as prescribed in the schedule hereto.
2. This warranty does not apply to any defect, loss or damage arising or caused directly or indirectly by or as a result of;
  - (i) Any masonry rendered or other surfaces cracking or collapsing during installation of the door.
  - (ii) Any defect or deterioration of timber including drying out after installation.
  - (iii) Any weakening or collapse of the structure to which the doors are affixed occurring any time after installation.
  - (iv) Any damage to or deterioration in the condition of the doors occurring in transit by customer nominated or appointed carrier or occurring after delivery and prior to installation.
  - (v) Any defect (including defects in component parts or accessories) rising from or attributable to the failure to carry out normal preventive maintenance or adjustment.
  - (vi) To any additional defect damage or deterioration arising from or attributable to the operation of the door after it is known to be defective.
  - (vii) Any door being installed within 800 metres of the sea or other body of water of equivalent or greater salt concentration or in an area subject to industrial fall out.
  - (viii) Any fault or surge in customer's electricity supply.
  - (ix) The door striking an immovable object during travel.
  - (x) Garage doors should be inspected upon delivery and viewed in natural light (not direct sunlight) from a standard distance of 3 metres to view their overall appearance. From this distance the door panel should appear free from marks or distortion, stains, blemishes, indentations or scuffs. If any marks are only visible within 3 metres they will not be considered under warranty.
  - (xi) Over time, some scuffing may occur on front and rear surfaces of roller doors as a result of their normal operation, this does not affect performance and is not covered under the terms of the guarantee.
  - (xii) The manufacturing of sectional door panels employs roll forming or pressing of the steel skin to create the ribbed or Georgian features. Inherent in this process is the introduction of stresses into the steel that

may be visible when viewed at oblique angles or in strong direction light. Such distortions in no way affect the strength or performance of the door and do not form part of the warranty cover. Our manufacturing processes minimise these effects but may not eliminate them entirely. The door is considered to meet Gliderol's quality standard if no significant surface distortion can be seen when viewing a closed door from a central position at a distance of 3 metres under even light conditions. Strong directional light such as bright sunshine or car headlights may reveal minor distortions at such distances but are not part of the warranty cover.

### 3. Items excluded from warranty;

- (i) Batteries
- (ii) Fuses
- (iii) Globes
- (iv) Sensitivity adjustments
- (iv) Minor factory repairs

4. While Gliderol doors are long lasting and hard wearing under normal conditions this warranty does not extend to inherent defects in steel or other material used in the manufacture. The Manufacturer will however, procure and assign to the customer the benefit of the warranty of the manufacturer of the steel or other material.

5. If Manufacturer has at request of customer procured painting, powder-coating or other surface application to its product this warranty does not extend to such painting, powder-coating or other surface application. For this purpose Manufacturer at all times acts as agent of customer. Manufacturer may as a service to the customer but without any legal obligation to do so, assist customer to obtain redress in respect of any defect.

6. The Manufacturer reserves the right to touch up on site the paint finish and or pre-painted surfaces on its range of garage doors but no responsibility will be taken for the possibility of any paint rubs, scuffing etc on the internal wash coat finish or external painted surface.

7. Proof of purchase MUST be provided to the manufacturer at time of warranty claim. If proof is not available any warranty may be invalid.

## CONDITIONS OF SALE AND INSTALLATION

### (If installation carried out by Gliderol or an other installation company)

1. Manufacture of Gliderol Doors will not commence until accurate site measurements are available and can be checked.
2. Where Gliderol Doors are made to suit floor levels, lintel heights or opening sizes guaranteed by the customer, any departure from the given sizes will be the responsibility of the customer as will any costs involved in alteration of made-up Gliderol Doors.
3. Any delivery, and/or installation dates given are approximate only and the Manufacturer accepts no liability for delay from any cause whatsoever. If by any reason or Act of God, war, government or semi-government enactment, regulation or restriction, lock-out, strike, industrial dispute, fire, tempest, flood, failure or inability to obtain licenses, transport or materials or any other cause beyond the Manufacturer's control delivery or installation is delayed the Manufacturer may extend the time of delivery or installation or if the Manufacturer is unable to deliver or install, the contract shall be voidable at the Manufacturer's option with no right to either party for damage, loss, cost or expense.
4. If these conditions of sale (which shall only be varied, modified or rescinded by written agreement executed by the Manufacturer) shall differ in any respect from the customer's acceptance or confirmation then these conditions shall prevail.
5. Any claim for damaged product must be made within 7 days of installation or delivery.
6. The Manufacturer may carry out installation or may nominate an accredited Installer Contractor to carry out the work. Installation is then a matter of separate contract with the Installer whose particulars is either provided in this quotation or will be provided upon confirmation by the customer. The Manufacturer has taken all reasonable care to ensure that any Installer Contractor nominated is competent, experienced and skilled in the installation of the Manufacturer's doors. The Manufacturer will at all times use its influence to ensure any installation complaint is dealt with promptly and resolved to the reasonable satisfaction of the customer. The customer's attention is also directed to the terms of the warranty above. However the manufacturer is not responsible or liable for any installers or contractors standard of workmanship and or ability to install any product or possible service issues thereafter.
7. Installation by Gliderol or installer contractors covers only the installation if the door and not, unless specifically stated, and rectification of existing out-of-square openings or removal of old doors and fittings or electricity of gas fittings or the like. Installation by Gliderol does not include the removal or taking away of old doors from the property or of disposing of such doors.
8. Whilst reasonable care will be taken while drilling and fixing, the Manufacturer and its Installers will not be responsible for the failure, from any cause whatsoever, of any masonry or rendered surfaces while drilling or fixing by cracking or collapsing.

Gliderol Garage Doors Ltd, Davy Drive, North West Industrial Estate, Peterlee, Co Durham SR8 2JF  
Tel: (0191) 518 0455 Fax: (0191) 518 0548 E-mail: info@gliderol.co.uk Web: www.gliderol.co.uk

Please Note: As ours is a policy of progressive design we reserve the right to change specification without prior notice. All colours shown are limited by the printing process and will not be a precise match for actual finishes. Please request samples of finishes to confirm your choice. Errors and omissions excepted.